

Муфта соединительная электросварная

PN 10 – SDR 17

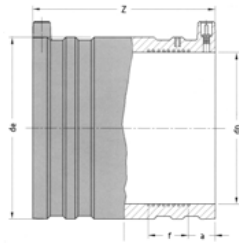

d _n	d _e	L	Размеры			Масса, гр
			f	a	Z	
110						
160	198	86	39	22	172	1550
180	223	100	41	25	199	2150
200	233	106	42	30	212	1930
225	262	114	41	35	227	2600
250	292	122	45	42	244	3600
280	341	133	42	44	265	7100
315	369	138	47	44	275	6630
355	430	156	40	47	312	11750
400	461	170	60	41	340	14150
450	505				340	16250
500					360	21750
560					400	30000
630					440	40667
710					500	56500
800					500	68000

PN 16 – SDR 11

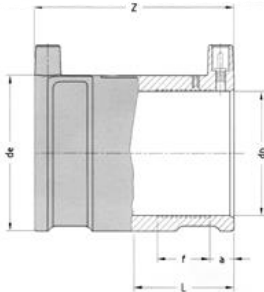

d _n	d _e	L	Размеры			Масса
			f	a	Z	
20	33	33	15	13	70	45
25	38	33	15	12	70	55
32	46	38	19	12	80	75
40	56	44	22	13	90	110
50	68	49	23	14	100	155
63	82	54	26	18	111	225
75	93	61	36	15	121	270
90	114	66	37	15	132	430
110	137	70	36	18	140	645
125	153	76	39	18	152	840
140	171	82	48	19	163	1090
160	198	86	45	22	172	1550
180	223	100	51	25	198	2150
200	247	105	42	32	211	3070
225	278	113	48	36	226	3950
250	308	122	53	33	244	5300
280	341	133	55	38	265	7100
315	391	138	70	33	275	9650
355	430	156	60	45	312	11750
400	497	171	53	64	343	19300

PN 12,5 – SDR 13,6

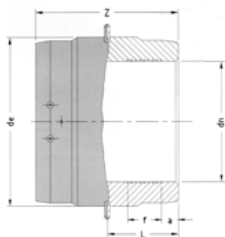

d _n	d _e	L	Размеры			Масса
			f	a	Z	
450	527	175	59	45	350	16500
500	585	179	76	47	359	22000
560	656	195	90	50	390	33200
630	736	210	99	50	420	46850

Гарантируемый класс давления 16 бар

PN 25 – SDR 7,4

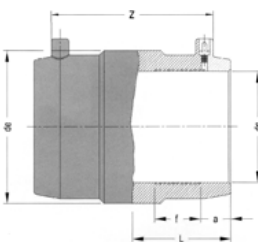

d _n	d _e	L	Размеры			Масса
			f	a	Z	
20	33	33	15	13	70	45
25	38	33	15	12	70	55
32	46	38	19	12	80	75
40	56	44	22	13	90	110
50	68	49	23	14	100	155
63	82	54	26	18	111	225
75	99	60	36	14	120	330
90	116	65	37	14	130	490
110	145	70	36	18	140	800
125	163	76	39	18	151	1060
140	183	81	48	18	161	1440
160	207	86	53	20	172	1950
180	233	97	56	23	193	2550
200	260	101	65	22	203	3440
225	292	112	67	22	223	4190
250	324	122	60	32	244	5900
315	408	142	70	37	284	10750

Отвод электросварной 45°

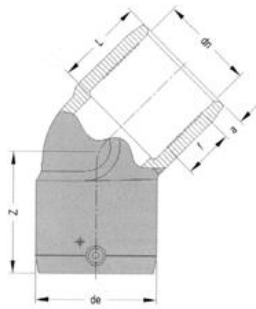

Размеры								Масса
d _n	d _e	L	f	a	Z	PN - SDR		
25	39	33	15	10	55	PN 25-SDR 7,4		80
32	46	39	18	10	57	PN 25-SDR 7,4		110
40	56	48	25	11	70	PN 25-SDR 7,4		175
50	68	54	27	12	75	PN 25-SDR 7,4		260
63	82	52	27	13	86	PN 25-SDR 7,4		390
75	97	64	29	18	98	PN 25-SDR 7,4		610
90	116	70	37	18	110	PN 25-SDR 7,4		905
110	142	76	39	20	114	PN 25-SDR 7,4		1415
125	162	79	42	19	119	PN 16-SDR II		1830
140	177	86	39	20	134	PN 16-SDR II		2200
160	206	89	45	20	134	PN 16-SDR II		3400
180	223	105	50	28	165	PN 16-SDR II		4050
200	250	112	55	29	171	PN 16-SDR II		5560
225	274	124			277	PN 16-SDR II		8625
250	308	132			292	PN 16-SDR II		14110
315	380	155			337	PN 16-SDR II		

Отвод электросварной 90°

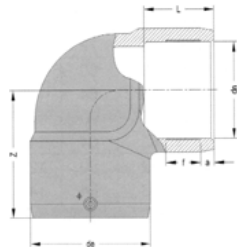

Размеры								Масса
d _n	d _e	L	f	a	Z	PN - SDR		
20	34	33	15	10	55	PN 25-SDR 7,4		70
25	38	33	15	9	57	PN 25-SDR 7,4		80
32	46	39	18	10	75	PN 25-SDR 7,4		130
40	56	48	25	11	80	PN 25-SDR 7,4		190
50	68	54	27	12	89	PN 25-SDR 7,4		300
63	83	52	27	13	104	PN 25-SDR 7,4		450
75	97	64	29	18	116	PN 25-SDR 7,4		665
90	116	70	37	18	130	PN 25-SDR 7,4		1040
110	142	76	39	20	146	PN 25-SDR 7,4		1615
125	162	79	42	19	152	PN 16-SDR II		2130
140	174	85	38	20	166	PN 16-SDR II		2520
160	206	89	45	20	180	PN 16-SDR II		4050
180	226	116	50	23	215	PN 16-SDR II		4900
200	251	118	55	23	229	PN 16-SDR II		6450
225	274	124			337	PN 16-SDR II		8950
250	308	132			385	PN 16-SDR II		11550
315	380	155			422	PN 16-SDR II		23040

Тройник электросварной

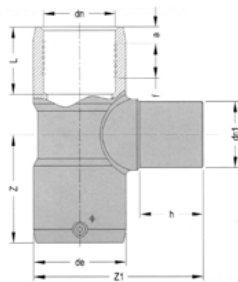

Размеры									Масса
d _n	d _{n1}	d _e	L	f	a	h	Z	Z ¹	PN 16 SDR 11
20	20	32	37,5			46	45	83	76
25	25	39	33	15	11	60	53	111	95
32	32	44	44	28	10	48	64	94	105
40	40	54	49	37	11	57	73	112	175
50	50	66	55	36	12	62	81	128	300
63	63	81	61	32	13	72	94	153	420
75	75	96	64	29	18	75	113	176	700
90	90	116	70	37	18	85	125	202	1170
110	110	141	76	39	20	84	141	233	1725
125	125	161	79	42	19	100	156	269	2800
140	140	174	85	38	20	121	150	308	3050
160	160	206	89	51	20	127	184	350	5570
180	180	227	105	48	23	130	188	368	6340
200	200	252	112	55	23	135	205	400	8230
225	225	274	124			125	342	412	18500
250	250	308	120			135	377	459	20714
315	315	380	155			150	427	540	

Тройник электросварной редукционный

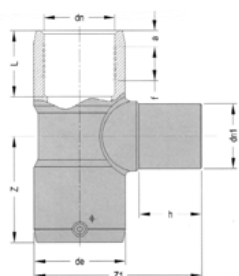

Размеры									Масса
d _n	d _{n1}	d _e	L	f	a	h	Z	Z ¹	PN 16 SDR 11
110	63	140	83			68,5	144	220	1594
110	90	140	83			88,5	144	240	1725
125	63	159	88			68,5	157,5	241,5	2200
125	90	159	88			90	157,5	261,5	2333
125	110	195	88			88,5	157,5	261,5	2433
160	63	195	90			78,5	155	283	3000
160	90	195	90			83,5	155	288	2880
160	110	195	90			88,5	155	293	3020
160	125	195	90			93,5	155	298	3120

Седелка электросварная без фрезы

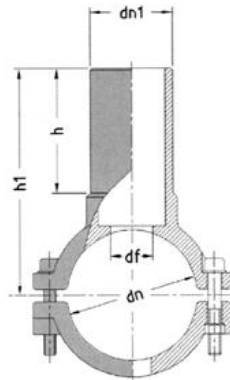
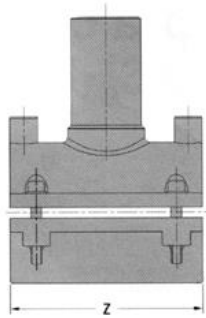
Размеры
Масса

d_n	d_{n1}	h	h_1	Z	d_f	PN16 SDR11
40x	20	65	99	84	13	75
x	25	65	100	84	17	80
x	32	65	101	84	25	85
50x	20	52	159	101	13	300
x	25	59	165	101	17	300
x	32	110	170	101	25	300
x	40	70	107	100		294
63x	20	60	110	110	13	150
x	25	60	110	110	17	160
x	32	65	112	110	25	170
x	40	65	115	110	32	180
x	50	80	135	110	38	210
x	63	75	142	132		343
75x	25	65	123	125	17	400
x	32	65	123	125	25	405
x	40	70	128	125	32	415
x	50	80	144	125	38	445
x	63	90	159	125	48	500
90x	20	55	121	125	13	450
x	25	55	121	125	17	460
x	32	55	121	125	25	470
x	40	60	126	125	32	460
x	50	65	137	125	38	500
x	63	73	150	125	48	610
110x	25	60	137	162	17	360
x	32	65	141	162	25	365
x	40	65	141	162	32	375
x	50	80	161	162	38	405
x	63	85	170	162	48	450
x	90	90	175	170		990
x	110	95	198	174		1240
125x	25	56	143	160	17	1100
x	32	57	143	160	25	1140
x	40	62	147	160	32	1145
x	50	67	158	160	38	1150
x	63	75	173	160	48	1000
x	90	93	191	190	72	1260
140x	25	65	159	160	17	920
x	32	65	159	160	25	925
x	40	70	163	160	32	935
x	50	80	179	160	38	965
x	63	90	194	160	48	1025
160x	25	65	169	160	17	680
x	32	65	169	160	25	700
x	40	73	173	160	32	710
x	50	80	189	160	38	740
x	63	90	204	160	48	800
x	90	90	208	190	72	1700
x	110	96	216	190	88	1890
x	160	160	280	240		
180x	25	56	221	160	17	1800
x	32	65	179	160	25	1235
x	40	70	183	160	32	1245
x	50	80	199	160	38	1275
x	63	90	214	160	48	1325
x	90	93	218	190	72	2110
x	110	94	226	190	88	2250
200x	25	65	189	160	17	1680
x	32	65	189	160	25	1690
x	40	70	193	160	32	1700
x	50	80	210	160	38	1730
x	63	90	225	160	48	1780
x	90	93	229	190	72	2000
x	110	93	237	190	88	2160
225x	25	65	201	160	17	1880
x	32	65	201	160	25	1890
x	40	70	206	160	32	1900
x	50	80	222	160	38	1930
x	63	90	237	190	48	1980
x	90	93	241	190	72	2200
x	110	98	249	190	88	2360
x	225	150	348	320		
250x	32	58	205	190	25	2200
x	40	63	210	190	32	2200
x	50	68	221	190	38	2200
x	63	77	234	190	48	2200
x	90	93	254	190	72	2750
x	110	98	262	190	88	2900
280	32	65	240	140		498
	63	65	240	140		550
	90	98	270	200		1500
	110	98	270	200		1720
315	32	65	257,5	140		493
	63	65	257,5	140		573
	110	98	287,5	200		1692
	160	160	357,5	240		8000
355-630	63	85	280	140		333
400	160	160	400	240		8000

Седелка электросварная с фрезой

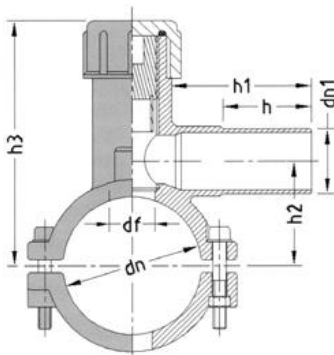
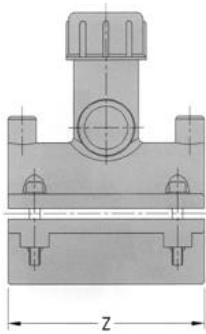
Размеры
Масса

d_n	d_{n1}	d_f	h	h^1	h^2	h_3	Z	PN16 SDR11
40x	20	16	66	96	29	110	84	190
x	25	16	66	96	29	110	84	200
x	32	18	66	96	29	110	84	205
50x	20	16	50	54	71	131	101	290
x	25	16	54	54	71	131	101	290
x	32	18	60	78	40	102	102	290
63x	20	25	70	90	55	136	110	430
x	25	25	70	90	55	136	110	460
x	32	25	70	105	55	136	110	470
x	40	25	70	120	55	136	110	510
	50		62			176	130	820
	63		62			176	130	855
75x	20	25	70	90	63	133	125	610
x	25	25	70	90	63	133	125	585
x	32	25	70	107	74	133	125	600
x	40	25	72	120	63	133	125	610
x	50	30	72	120	63	160	125	770
x	63	30	93	120	63	160	125	610
90x	20	25	70	90	70	146	125	660
x	25	25	70	90	70	146	125	660
x	32	25	70	105	70	146	125	660
x	40	25	72	120	70	146	125	660
x	50	30	72	120	73	171	125	660
x	63	30	93	120	73	171	125	880
110x	20	25	76	130	71	208	162	570
x	25	25	76	130	71	208	162	595
x	32	25	76	135	71	208	162	605
x	40	25	76	139	71	208	162	615
x	50	30	80	144	71	208	162	640
x	63	30	85	148	71	208	162	675
125x	20	25	70	90	87	165	160	1230
x	25	25	70	90	87	165	160	1110
x	32	25	70	108	84	165	160	1125
x	40	25	72	120	87	165	160	1155
x	50	30	72	120	87	187	160	1295
x	63	30	83	120	87	187	160	1330
140x	20	25	70	90	96	165	160	1350
x	25	25	70	90	96	165	160	1350
x	32	25	70	105	96	165	160	1335
x	40	25	72	120	96	165	160	1350
x	50	30	72	120	96	167	160	1350
x	63	30	73	120	96	167	160	1585
160x	20	25	70	90	108	184	160	1375
x	25	25	70	90	104	184	160	1395
x	32	25	70	106	105	185	160	1400
x	40	25	72	120	104	185	160	1400
x	50	30	72	120	104	208	160	1400
x	63	30	72	120	104	208	160	1600
180x	20	25	70	90	110	192	160	1750
x	25	25	70	90	110	192	160	1765
x	32	25	70	105	110	192	160	1775
x	40	25	72	120	110	192	160	1775
x	50	30	72	120	110	194	160	1775
x	63	30	72	120	110	194	160	2118
200x	20	25	70	90	126	204	160	1850
x	25	25	70	90	126	204	160	1910
x	32	25	70	105	126	204	160	2040
x	40	25	72	120	126	204	160	1910
x	50	30	72	120	126	194	160	1910
x	63	30	64	120	126	194	160	2095
225x	20	25	70	90	140	216	160	2055
x	25	25	70	90	140	216	160	2080
x	32	25	70	105	140	216	160	2070
x	40	25	72	120	140	216	160	2080
x	50	30	72	120	140	218	160	2080
x	63	30	64	120	140	218	160	2290
250x	20	25	70	90	151	264	160	2475
x	25	25	70	90	151	264	160	2400
x	32	30	70	105	151	266	160	2595
x	40	30	72	120	151	266	160	2400
x	50	30	72	120	151	266	160	2400
x	63	30	64	120	151	266	160	2935
280	32		70			305	150	1425
	63		90			350	150	2217
315	32		70			320	150	1445
	63		90			367	150	2233
355-630	63		90				150	1550

Переход электросварной

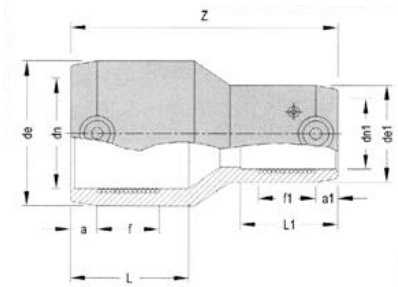

d _n	d _{e1}	d _e	d _{e1}	Размеры						Масса		
				L	L ₁	f	f ₁	a	a ₁	Z	PN 16 SDR 11	
25x	20	36		40	37						85	75
32x	20	44	32	46	38	34	22	10	10	105		75
32x	25	45	36	44	45	31	21	10	10	103		75
40x	20	55	33	49	39	27	22	11	10	120		105
40x	25	55	36	48	40	27	21	11	10	114		100
40x	32	55	44	54	50	30	29	11	10	109		100
50x	25	67	37	49	40	27	21	12	10	126		140
50x	32	66	44	53	49	30	29	12	10	121		170
50x	40	66	54	55	54	33	33	12	11	119		200
63x	32	81	46	62	44	31	24	15	12	156		245
63x	40	81	54	63	54	29	20	15	13	137		250
63x	50	81	66	62	54	26	23	16	16	131		250
75x	50	97	66	70	54	34	30	13	11	154		345
75x	63	97	81	75	62	34	33	13	13	160		395
90x	50	117	66	79	55	45	25	18	16	185		555
90x	63	115	81	77	62	45	33	15	13	160		515
90x	75	115	97	81	60	39	30	18	18	159		550
110x	63	144	83	79	63	40	33	20	15	201		905
110x	90	141	115	87	77	41	39	19	18	181		860
125x	63	150		76	65					162,5		720
125x	90	162	118	78	68	42	34	22	17	177		1100
125x	110	162	144	79	73	33	36	22	20	164		1225
160x	90	209	119	90	79	50	50	23	17	233		2130
160x1	110	208	144	95	82	48	37	25	20	218		2400
160x	125	208	162	98	87	47	30	26	21	208		2505
200x	160	250		113	102					225		3232
200x	180	250		113	112					235		3232
225x	160	278		124	103					255		5500
225x	200	278		124	112					255		
250x	180	278		124	113					255		
250x	200	305		119	98					242		6500
250x	225	308		135	125					275		6500
315x	250	390		120	120					270		
315x	280	390		135	130					295		

Заглушка электросварная

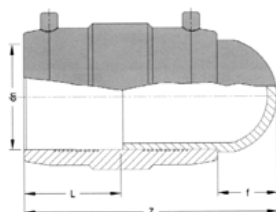

d _n	Размеры PN 16 - SDR 11			Размеры PN 25 - SDR 7,4			Масса	
	f	L	Z	f	L	Z	SDR 11 PN 16	SDR 7,4 PN 25
20			30	33	100			60
25				27	33	104		75
32	31	38	98	31	38	98	95	100
40	29	44	114	29	44	114	140	155
50	32	49	127	32	49	127	205	250
63	49	55	136	55	136	136	310	360
75	41	61	162	41	60	164	430	550
90	42	66	174	52	65	164	680	850
110	49	70	189	61	70	187	1075	1400
125	42	76	194	42	76	198	1440	1800
140	51	82	214	51	81	207	1900	2400
160	48	86	220	45	86	211	2535	3300
180	50	100	249				3635	
200								
225		104	253				6400	
250		106	256				7600	
280			227				14500	
315			328				17900	