



POELSAN

YENİ MAVİ SERİ
ÜRÜN KATALOĞU

NEW BLUE SERIES
PRODUCTION CATALOGUE





Poelsan Dünya Firmalarıyla Rekabet Ediyor...

✚ Poelsan, 1994 yılında henüz ülkemizde üretimi yapılmadığı için ithal edilen Polietilen Kangal Boru Bağlantı Adaptörlerini, kendi tesisinde üreterek piyasaya sunan ilk firma olmuştur.

Poelsan ürünleri, başta peyzaj sektörü olmak üzere, içme suyu şebekelerinde, tarım alanlarında, seralarda, damla sulama sistemlerinde güvenle kullanılabilir. Poelsan ürünleri, başta peyzaj sektörü olmak üzere, içme suyu şebekelerinde, tarım alanlarında, seralarda, damla sulama sistemlerinde güvenle kullanılabilir.

Poelsan, 52.000 m² alanda yıllık 10.522 ton plastik işleme kapasitesiyle üretim yapmaktadır. Poelsan, yurt içinde tüm illere yayılmış yaklaşık 400 bayi ile çalışmakta ve 60 ülkeye ihracat yapmaktadır.

Poelsan, 2.000'in üzerinde ürün çeşidine sahiptir ve sektördeki yeniliklere bağlı olarak mevcut ürün çeşidini sürekli olarak arttırmayı ve sektöründe bir dünya markası olmayı hedeflemektedir.

Poelsan is in the Global Market...

✚ Poelsan is the first company that produced and marketed the Compression Fittings for PE Roll Pipes at its own plant, as the mentioned products cannot be produced in the country and consequently been imported up to the year 1994.

Our products can be used safely in the areas of landscaping, potable water networks, agricultural irrigation, drip irrigation and greenhouses.

Poelsan makes production in 52.000 m² area with its annual plastic process of 10.522 tones. Poelsan cooperates with 400 domestic distributors overall provinces in Turkey and also exports to 60 countries presently.

Poelsan has a wide product range consisting of more than 2.000 items and our company aims to extend its current product range consistently depending on the developments in the sector and to be a global brand.

Misyonumuz

- + Yüksek kalite ve teknolojinin buluşması ile plastik boru ek parça üretiminde yerel ve küresel pazarda öncü bir marka olmak.

Vizyonumuz

- + Plastik boru bağlantı sistemlerinde yakın coğrafyada lider, global pazarda tercih edilen bir marka olmak.

Değerlerimiz

- + İnsan ve Çevreye Saygı
- + Liderlik
- + Güvenilirlik
- + Değerli Hissettirmek
- + Gelişime ve Yeniliğe Açık
- + Takım Ruhu

Our Mission

- + To be a leading brand in the local and global market in the production of plastic pipe fittings with the combination of high quality and technology.

Our Vision

- + To become the leader in the nearby geography in plastic pipe connection systems, and a preferred brand in global market.

Our Values

- + Respect for Human and Environment
- + Leadership
- + Reliability
- + Making Feel Special
- + Open for Development and Innovation
- + Team Spirit





65 **2.000** Üzerinde **Ürün Çeşidi**
ÜLKEYE İHRACAT

More than 2.000 products range
in 65 countries

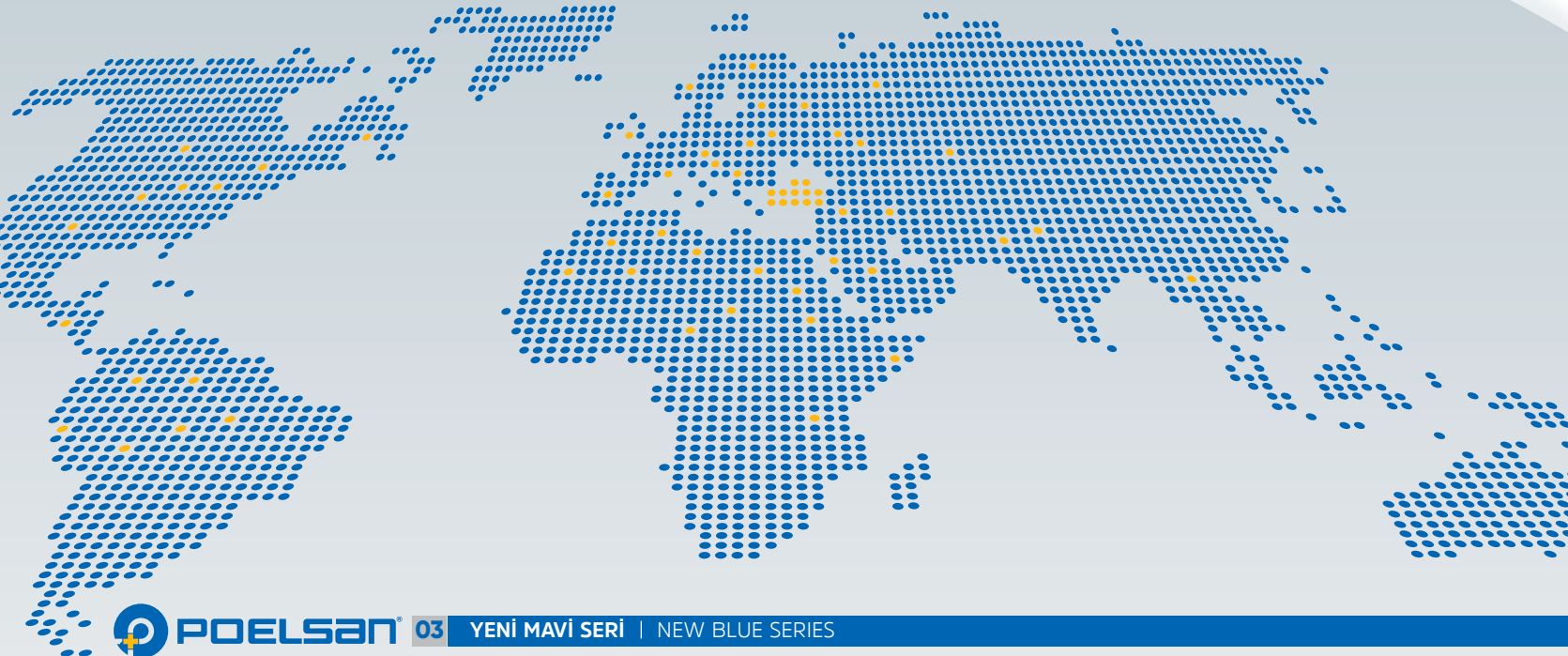

ALMANYA + ARJANTİN + ARNAVUTLUK + AVUSTRALYA + AZERBAYCAN + BELARUS
BOLİVYA + BREZİLYA + BULGARİSTAN + BOSNA HERSEK + CEZAYİR
ÇEK CUMHURİYETİ + EKVADOR + ERMENİSTAN + ETİYOPYA + FAS + FİLİSTİN
FRANSA + GÜRCİSTAN + HIRVATİSTAN + HİNDİSTAN + HOLLANDA + IRAK + İNGİLTERE
İRAN + İRLANDA + İSPANYA + İSRAİL + İTALYA + KARADAĞ + KATAR + KAZAKİSTAN
K.K.T.C + KOSOVA + KOSTA RİKA + KUVEYT + LETONYA + LİBYA + LÜBNAN
MACARİSTAN + MISIR + MOLDOVA + NORVEÇ + ÖZBEKİSTAN + PAKİSTAN
PERU + POLONYA + PORTEKİZ + ROMANYA + RUSYA + SİRBİSTAN + SURİYE
SUUDİ ARABİSTAN + SLOVAKYA + ŞİLİ + TAYLAND + TUNUS + TÜRKMENİSTAN
UKRAYNA + URUGUAY + ÜRDÜN + VENEZUELA + YEMEN + YENİ ZELANDA + YUNANİSTAN
ALBANIA + ALGERIA + ARGENTINA + ARMENIA + AUSTRALIA + AZERBAIJAN + BELARUS + BOLIVIA
BRAZIL + BULGARIA + BOSNIA AND HERZEGOVINA + CHILE + CZECH REPUBLIC + CROATIA
COSTA RICA + ECUADOR + EGYPT + ENGLAND + ETHIOPIA + FRANCE
GEORGIA + GERMANY + GREECE + HOLLAND + HUNGARY + INDIA + IRAN + IRELAND + IRAQ
ISRAEL + ITALY + JORDAN + KAZAKHSTAN + KOSOVO + KUWAIT + LATVIA
LEBANON + LIBYA + MOLDOVA + MONTENEGRO + MOROCCO + NEW ZEALAND
NORWAY + PAKISTAN + PALESTINE + PERU
POLAND + PORTUGAL + QATAR + ROMANIA + RUSSIA + SLOVAKIA
SAUDI ARABIA + SERBIA + SPAIN + SYRIA + THAILAND
TUNISIA + TURKMENISTAN + T.R.N.C + UZBEKISTAN
UKRAINE + URUGUAY + VENEZUELA + YEMEN



Yeni Mavi Seri Özellikler	7
Kablin Erkek	8
Kablin Manşon	9
Kablin Te	9
Kablin Erkek Te	10
Kablin Dirsek	11
Kablin Erkek Dirsek	12
Kablin Redüksiyon Te	13
Kablin Redüksiyon Manşon	14
Kablin Redüksiyon Dirsek	15
Kablin Kör Tapa	16
Galvaniz Metal Yüzüklü	
Kablin Dişi	17
Kablin Dişi Te	18
Kablin Dişi Dirsek	19
Paslanmaz Metal Yüzüklü (AISI430)	
Kablin Dişi	20
Kablin Dişi Te	21
Kablin Dişi Dirsek	22
Tamir Manşonu - Kablin Anahtarı	23
ISO 17885 Standardı - Testler	24
Dikkat Edilmesi Gereken Hususlar	25
Tesisatın Son Kontrolü	26
Adaptörlerin Montaj Yöntemleri	27
<i>(Ø20-Ø25-Ø32-Ø40-Ø50 mm adaptörler)</i>	
Adaptörlerin Montaj Yöntemleri	28
<i>(Ø63-Ø75-Ø90-Ø110 mm adaptörler)</i>	
Belgelerimiz	29

Specifications of New Blue Series	7
Male Adaptor	8
Coupling	9
Tee	9
Male Tee	10
Elbow	11
Male Elbow	12
Reducing Tee	13
Reducing Coupling	14
Reducing Elbow	15
End Cap	16
Galvanized Reinforcement Ring	
Female Adaptor	17
Female Tee	18
Female Elbow	19
Stainless Steel Reinforcement Ring (AISI430)	
Female Adaptor	20
Female Tee	21
Female Elbow	22
Repairing Coupling - Fitting Spanner	23
ISO 17885 Standard - Tests	24
Points to Take Into Consideration	25
Final Check of the Installation	26
How to Install the Fittings	27
<i>(Ø20-Ø25-Ø32-Ø40-Ø50 mm adaptors)</i>	
How to Install the Fittings	28
<i>(Ø63-Ø75-Ø90-Ø110 mm adaptors)</i>	
Certificates	29

NEW BLUE SERIES



POELSAN®



TS ISO 17885



Özellikler

- + Darbelere karşı dayanıklı, yüksek kaliteli polipropilen hammaddeden üretilmiştir.
- + Borulardaki ± 0.5 mm'ye kadar olan ölçü farklılıklarından veya ovalikten oluşabilecek sorunları **konik sıkma özelliği** sayesinde önler.
- + UV ışınlarını geçirmediği için **yosunlanmaya ve bakteri üremesine izin vermez.**
- + Oringi kauçuktan üretilmekte olup **yüksek sızdırmazlık sağlar.**
- + İç yüzeyleri **homojen ve gözeneksizdir.**
- + Suyun kokusunu ve tadını değiştirebilecek **hiçbir yabancı madde içermez.**
- + Dişi ürünlerimiz kullanılan korozyona dayanıklı **metal yüzük sayesinde uzun vadede değişken sıcaklıklarda yüksek sızdırmazlık sağlar.**

Specifications

- + It has been produced from high quality polypropylene raw material and **it has resistance to impact.**
- + **Due to conical tightening**, they remove faults in pipes that may be caused by dimensional differences and ovality **up to ± 0.5 mm.**
- + **They prevent alga and bacteria forming** due to UV proof (ultraviolet beam) structure.
- + O-rings are made of rubber and **provide high leakproofness.**
- + **It has a homogeneous and non-porous inner surface.**
- + **It does not contain any foreign substance which can change the taste or the smell of the water.**
- + Female threaded products provide high impermeability **in the long term changeable temperature values thanks to corrosion resistant reinforcing ring.**



TS ISO 17885

KULLANIM ALANLARI

- + Şehir Şebekesi İçme Suyu
- + Peyzaj Sektörü
- + Tarımsal Sulama
- + Seralar

INSTALLATION AREAS

- + Urban Potable Water Networks
- + Landscaping Systems
- + Agricultural Irrigation
- + Greenhouses

GARANTİ VERİLEN BASINÇ DEĞERLERİ

GUARANTEED PRESSURE VALUES

Ø 20 mm – Ø 110 mm: PN 16

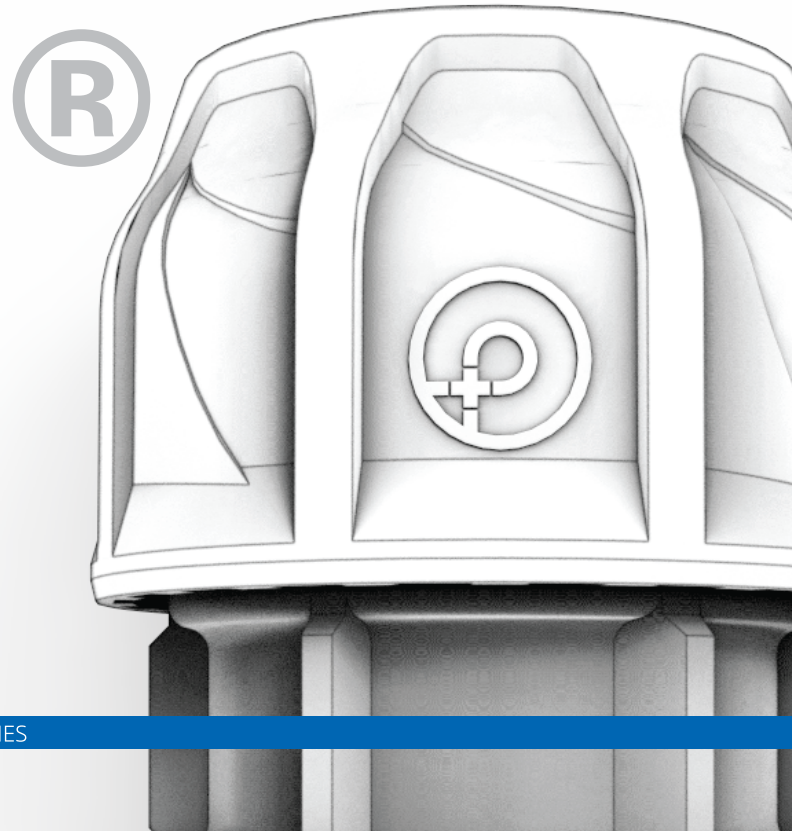

KOD CODE	EBAT/SIZE d x G	AMBALAJ ADEDİ PACKING QUANTITY	KOLİ ADEDİ BOX QUANTITY	ÇUVAL ADEDİ SACK QUANTITY
10001011	20 x ½"	50	800	850
10001012	20 x ¾"	50	700	800
10001021	25 x ½"	25	550	550
10001022	25 x ¾"	25	500	500
10001023	25 x 1"	25	450	500
10001031	32 x ½"	25	300	350
10001032	32 x ¾"	25	300	325
10001033	32 x 1"	25	275	325
10001034	32 x 1 ¼"	25	250	300
10001043	40 x 1"	15	150	180
10001044	40 x 1 ¼"	15	150	180
10001045	40 x 1 ½"	15	150	165
10001054	50 x 1 ¼"	10	90	110
10001055	50 x 1 ½"	10	90	100
10001056	50 x 2"	10	90	100
10001065	63 x 1 ½"	6	60	66
10001066	63 x 2"	6	54	60
10001067	63 x 2 ½"	6	54	54
10001076	75 x 2"	4	32	36
10001077	75 x 2 ½"	4	32	32
10001078	75 x 3"	4	32	32
10001086	90 x 2"	4	20	20
10001087	90 x 2 ½"	4	16	20
10001088	90 x 3"	4	16	20
10001089	90 x 4"	4	16	20
10001095	110 x 2"	2	12	14
10001096	110 x 2 ½"	2	12	14
10001097	110 x 3"	2	12	14
10001098	110 x 4"	2	12	14



KABLİN ERKEK

MALE ADAPTOR

ΜΥΦΤΑ Σ ΗΛΕΚΤΡ. ΡΕ

س خرطوم سن خارجي

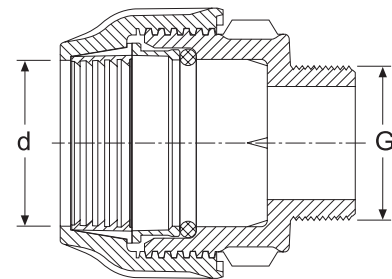



KABLİN MANŞON

COUPLING

МУФТА СОЕДИНИТЕЛЬНАЯ

وصلة خرطوم

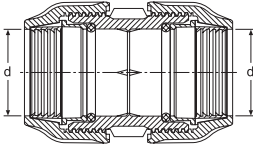

KOD CODE	EBAT/SIZE d x d	AMBALAJ ADEDİ PACKING QUANTITY	KOLİ ADEDİ BOX QUANTITY	ÇUVAL ADEDİ SACK QUANTITY
10002011	20 x 20	25	450	450
10002022	25 x 25	25	300	325
10002033	32 x 32	10	170	180
10002044	40 x 40	10	90	110
10002055	50 x 50	6	60	66
10002066	63 x 63	5	35	35
10002077	75 x 75	2	18	20
10002088	90 x 90	2	10	12
10002099	110 x 110	1	8	9



KABLİN TE

TEE

ТРОЙНИК

تی خرطوم

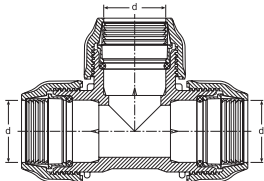

KOD CODE	EBAT/SIZE d x d x d	AMBALAJ ADEDİ PACKING QUANTITY	KOLİ ADEDİ BOX QUANTITY	ÇUVAL ADEDİ SACK QUANTITY
10002511	20 x 20 x 20	15	240	255
10002522	25 x 25 x 25	10	150	160
10002533	32 x 32 x 32	5	80	90
10002544	40 x 40 x 40	5	50	55
10002555	50 x 50 x 50	4	28	32
10002566	63 x 63 x 63	3	18	21
10002577	75 x 75 x 75	1	10	12
10002588	90 x 90 x 90	1	6	6
10002599	110 x 110 x 110	1	3	4



KABLİN ERKEK TE

MALE TEE

ТРОЙНИК С НАРУЖН.РЕ.З.

تي خرطوم سن خارجي

KOD CODE	EBAT/SIZE d x G x d	AMBALAJ ADEDİ PACKING QUANTITY	KOLİ ADEDİ BOX QUANTITY	ÇUVAL ADEDİ SACK QUANTITY
10003011	20 x 1/2" x 20	15	300	330
10003012	20 x 3/4" x 20	15	300	330
10003021	25 x 1/2" x 25	10	200	220
10003022	25 x 3/4" x 25	10	200	240
10003023	25 x 1" x 25	10	180	200
10003032	32 x 3/4" x 32	10	120	140
10003033	32 x 1" x 32	10	110	120
10003034	32 x 1 1/4" x 32	10	100	120
10003043	40 x 1" x 40	5	75	80
10003044	40 x 1 1/4" x 40	5	60	75
10003045	40 x 1 1/2" x 40	5	55	65
10003053	50 x 1" x 50	4	44	52
10003054	50 x 1 1/4" x 50	4	44	48
10003055	50 x 1 1/2" x 50	4	40	44
10003056	50 x 2" x 50	4	32	40
10003064	63 x 1 1/4" x 63	3	27	30
10003065	63 x 1 1/2" x 63	3	24	30
10003066	63 x 2" x 63	3	21	27
10003067	63 x 2 1/2" x 63	3	18	24
10003076	75 x 2" x 75	1	16	17
10003077	75 x 2 1/2" x 75	1	14	15
10003078	75 x 3" x 75	1	12	13
10003086	90 x 2" x 90	1	9	10
10003087	90 x 2 1/2" x 90	1	8	10
10003088	90 x 3" x 90	1	8	10
10003089	90 x 4" x 90	1	6	8
10003096	110 x 2 1/2" x 110	1	6	6
10003097	110 x 3" x 110	1	5	5
10003098	110 x 4" x 110	1	5	5

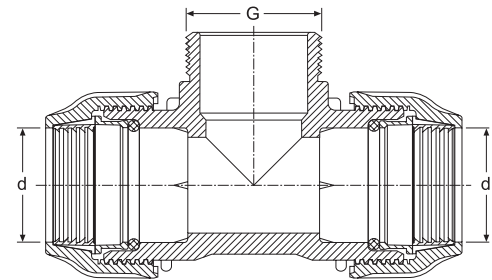



KOD CODE	EBAT/SIZE d x d	AMBALAJ ADEDİ PACKING QUANTITY	KOLİ ADEDİ BOX QUANTITY	ÇUVAL ADEDİ SACK QUANTITY
10004011	20 x 20	25	400	450
10004022	25 x 25	15	240	255
10004033	32 x 32	10	140	160
10004044	40 x 40	5	80	90
10004055	50 x 50	4	44	52
10004066	63 x 63	4	28	32
10004077	75 x 75	2	16	18
10004088	90 x 90	1	8	10
10004099	110 x 110	1	5	6

KABLİN DİRSEK

ELBOW

ОТВОД

زاوية خرطوم

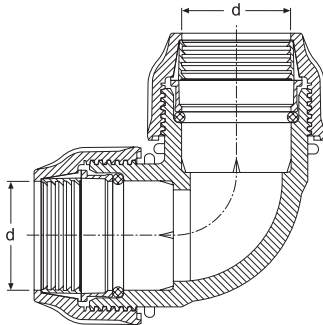

KOD CODE	EBAT/SİZE d x G	AMBALAJ ADEDİ PACKING QUANTITY	KOLİ ADEDİ BOX QUANTITY	ÇUVAL ADEDİ SACK QUANTITY
10004511	20 x ½"	25	600	700
10004512	20 x ¾"	25	550	600
10004521	25 x ½"	15	390	420
10004522	25 x ¾"	15	390	420
10004523	25 x 1"	15	330	360
10004532	32 x ¾"	10	240	250
10004533	32 x 1"	10	220	240
10004534	32 x 1 ¼"	10	200	200
10004543	40 x 1"	5	120	140
10004544	40 x 1 ¼"	5	120	130
10004545	40 x 1 ½"	5	110	125
10004554	50 x 1 ¼"	4	72	80
10004555	50 x 1 ½"	4	72	80
10004556	50 x 2"	4	64	72
10004565	63 x 1 ½"	4	44	52
10004566	63 x 2"	4	40	48
10004567	63 x 2 ½"	4	36	44
10004576	75 x 2"	2	24	28
10004577	75 x 2 ½"	2	24	24
10004578	75 x 3"	2	20	24
10004587	90 x 2 ½"	1	14	17
10004588	90 x 3"	1	14	17
10004589	90 x 4"	1	12	14
10004597	110 x 3"	1	8	11
10004598	110 x 4"	1	8	10



KABLİN ERKEK DİRSEK

MALE ELBOW

ОТВФД С НАРУЖН.РЕЗ.

زاوية خرطوم سن خارجي

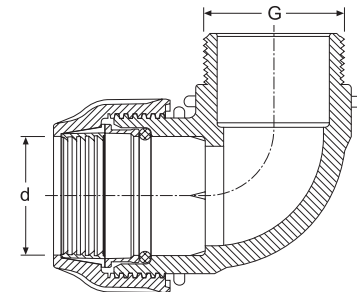



KABLİN REDÜKSİYON TE

REDUCING TEE

ТРОЙНИК ПЕРЕХОДНОЙ

تي خرطوم محول

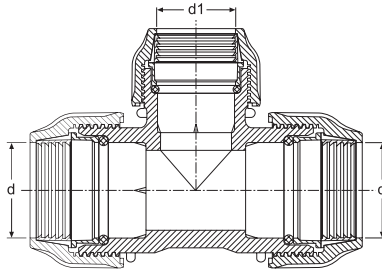

KOD CODE	EBAT/SIZE d x d, x d	AMBALAJ ADEDİ PACKING QUANTITY	KOLİ ADEDİ BOX QUANTITY	ÇUVAL ADEDİ SACK QUANTITY
10005521	25 x 20 x 25	10	180	200
10005531	32 x 20 x 32	5	120	120
10005532	32 x 25 x 32	5	100	115
10005542	40 x 25 x 40	5	65	75
10005543	40 x 32 x 40	5	55	65
10005552	50 x 25 x 50	4	40	44
10005553	50 x 32 x 50	4	40	44
10005554	50 x 40 x 50	4	40	40
10005563	63 x 32 x 63	3	24	30
10005564	63 x 40 x 63	3	21	24
10005565	63 x 50 x 63	3	21	24
10005575	75 x 50 x 75	1	14	14
10005576	75 x 63 x 75	1	12	14
10005586	90 x 63 x 90	1	8	9
10005587	90 x 75 x 90	1	7	8
10005596	110 x 63 x 110	1	6	6
10005598	110 x 90 x 110	1	4	5



KABLİN REDÜKSİYON MANŞON

REDUCING COUPLING

ПЕРЕХОДНИК

وصلة خرطوم محول

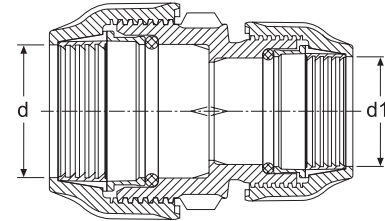

KOD CODE	EBAT/SIZE d x d ₁	AMBALAJ ADEDİ PACKING QUANTITY	KOLİ ADEDİ BOX QUANTITY	ÇUVAL ADEDİ SACK QUANTITY
10006021	25 x 20	25	350	400
10006031	32 x 20	10	240	270
10006032	32 x 25	10	200	240
10006041	40 x 20	10	150	170
10006042	40 x 25	10	140	160
10006043	40 x 32	10	120	130
10006052	50 x 25	6	90	102
10006053	50 x 32	6	84	96
10006054	50 x 40	6	72	78
10006062	63 x 25	6	54	60
10006063	63 x 32	6	48	60
10006064	63 x 40	6	48	54
10006065	63 x 50	6	36	48
10006075	75 x 50	2	28	32
10006076	75 x 63	2	24	24
10006086	90 x 63	2	14	18
10006087	90 x 75	2	12	16
10006097	110 x 75	1	8	11
10006098	110 x 90	1	8	10



KOD CODE	EBAT/SIZE d x d ₁	AMBALAJ ADEDİ PACKING QUANTITY	KOLİ ADEDİ BOX QUANTITY	ÇUVAL ADEDİ SACK QUANTITY
10006521	25 x 20	15	270	300
10006532	32 x 25	10	180	200
10006543	40 x 32	5	90	100
10006554	50 x 40	4	52	68
10006565	63 x 50	4	32	40
10006576	75 x 63	2	18	22
10006587	90 x 75	1	11	14
10006598	110 x 90	1	6	8

KABLİN REDÜKSİYON DİRSEK

REDUCING ELBOW
ОТВОД ПЕРЕХОДНОЙ
راویة خرطوم محول

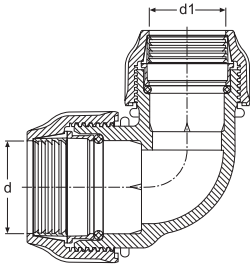



KOD CODE	EBAT/SIZE d	AMBALAJ ADEDİ PACKING QUANTITY	KOLİ ADEDİ BOX QUANTITY	ÇUVAL ADEDİ SACK QUANTITY
10007011	20	50	800	900
10007022	25	25	500	550
10007033	32	25	300	350
10007044	40	15	165	180
10007055	50	12	96	108
10007066	63	6	60	60
10007077	75	4	32	36
10007088	90	4	16	20
10007099	110	2	12	16

KABLİN KÖR TAPA

END CAP

ЗАГЛУШКА

راس نهاية خط

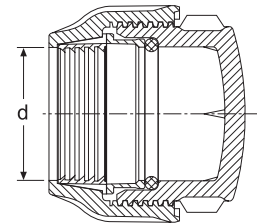



KABLİN DİŞİ

FEMALE ADAPTOR

МУФТА С ВНУТРЕН.РЕЗБ

زاس خرطوم سن داخلی

GALVANİZ METAL YÜZÜKLÜ

GALVANIZED REINFORCEMENT RING
Оцинкованное металлическое кольцо
حلقة معدنية مجلفنة سلسلة زرقاء جديدة

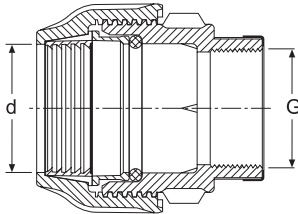

KOD CODE	EBAT/SIZE d x G	AMBALAJ ADEDİ PACKING QUANTITY	KOLİ ADEDİ BOX QUANTITY	ÇUVAL ADEDİ SACK QUANTITY
10008111	20 x 1/2"	50	700	750
10008112	20 x 3/4"	50	550	650
10008121	25 x 1/2"	25	450	500
10008122	25 x 3/4"	25	450	450
10008123	25 x 1"	25	350	400
10008132	32 x 3/4"	25	275	300
10008133	32 x 1"	25	250	275
10008134	32 x 1 1/4"	25	225	250
10008143	40 x 1"	15	150	180
10008144	40 x 1 1/4"	15	150	165
10008145	40 x 1 1/2"	15	135	150
10008154	50 x 1 1/4"	10	90	100
10008155	50 x 1 1/2"	10	90	100
10008156	50 x 2"	10	80	90
10008165	63 x 1 1/2"	6	54	60
10008166	63 x 2"	6	54	60
10008167	63 x 2 1/2"	6	48	48
10008176	75 x 2"	4	32	36
10008177	75 x 2 1/2"	4	32	32
10008178	75 x 3"	4	28	32
10008186	90 x 2"	4	16	20
10008187	90 x 2 1/2"	4	16	20
10008188	90 x 3"	4	16	20
10008189	90 x 4"	4	12	16
10008195	110 x 2"	2	12	16
10008196	110 x 2 1/2"	2	12	14
10008197	110 x 3"	2	12	14
10008198	110 x 4"	2	12	14



KOD CODE	EBAT/SIZE d x G x d	AMBALAJ ADEDİ PACKING QUANTITY	KOLİ ADEDİ BOX QUANTITY	ÇUVAL ADEDİ SACK QUANTITY
10008311	20 x 1/2" x 20	15	270	300
10008312	20 x 3/4" x 20	15	240	270
10008321	25 x 1/2" x 25	10	200	220
10008322	25 x 3/4" x 25	10	180	200
10008323	25 x 1" x 25	10	160	170
10008331	32 x 1/2" x 32	10	120	140
10008332	32 x 3/4" x 32	10	110	130
10008333	32 x 1" x 32	10	100	120
10008334	32 x 1 1/4" x 32	10	100	110
10008342	40 x 3/4" x 40	5	60	75
10008343	40 x 1" x 40	5	60	70
10008344	40 x 1 1/4" x 40	5	55	70
10008345	40 x 1 1/2" x 40	5	50	70
10008352	50 x 3/4" x 50	4	40	48
10008353	50 x 1" x 50	4	40	48
10008354	50 x 1 1/4" x 50	4	40	44
10008355	50 x 1 1/2" x 50	4	40	44
10008356	50 x 2" x 50	4	32	36
10008363	63 x 1" x 63	3	21	27
10008364	63 x 1 1/4" x 63	3	21	27
10008365	63 x 1 1/2" x 63	3	21	24
10008366	63 x 2" x 63	3	21	24
10008367	63 x 2 1/2" x 63	3	18	21
10008376	75 x 2" x 75	1	14	16
10008377	75 x 2 1/2" x 75	1	12	14
10008378	75 x 3" x 75	1	12	13
10008387	90 x 2 1/2" x 90	1	8	9
10008388	90 x 3" x 90	1	6	9
10008389	90 x 4" x 90	1	7	7
10008396	110 x 2 1/2" x 110	1	6	7
10008397	110 x 3" x 110	1	5	5
10008398	110 x 4" x 110	1	4	5



KABLİN DIŞI TE

FEMALE TEE

ТРОЙНИК С ВНУТРЕН.РЕЗ.

تي خرطوم سن داخلي

GALVANİZ METAL YÜZÜKLÜ

GALVANIZED REINFORCEMENT RING
Оцинкованное металлическое кольцо
حلقة معدنية مجلفنة سلسلة زرقاء جديدة

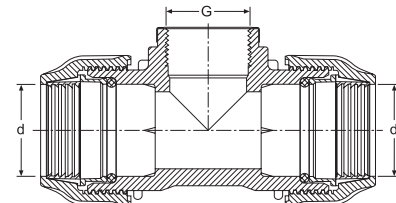



KABLIN DIŐI DİRSEK

FEMALE ELBOW

ОТВОД С ВНУТРЕ.РЕЗ.

زاوية خرطوم سن داخلي

GALVANİZ METAL YÜZÜKLÜ

GALVANIZED REINFORCEMENT RING

Оцинкованное металлическое кольцо

حلقة معدنية مجلفنة سلسلة زرقاء جديدة

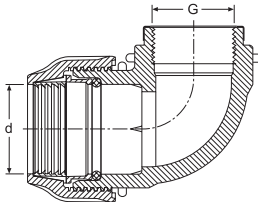

KOD CODE	EBAT/SIZE d x G	AMBALAJ ADEDİ PACKING QUANTITY	KOLİ ADEDİ BOX QUANTITY	ÇUVAL ADEDİ SACK QUANTITY
10008511	20 x 1/2"	25	550	600
10008512	20 x 3/4"	25	450	500
10008521	25 x 1/2"	15	360	390
10008522	25 x 3/4"	15	330	360
10008523	25 x 1"	15	270	300
10008532	32 x 3/4"	10	220	250
10008533	32 x 1"	10	180	220
10008534	32 x 1 1/4"	10	150	170
10008543	40 x 1"	5	120	130
10008544	40 x 1 1/4"	5	100	120
10008545	40 x 1 1/2"	5	90	100
10008554	50 x 1 1/4"	4	72	80
10008555	50 x 1 1/2"	4	60	68
10008556	50 x 2"	4	52	64
10008565	63 x 1 1/2"	4	40	52
10008566	63 x 2"	4	40	48
10008567	63 x 2 1/2"	4	32	40
10008576	75 x 2"	2	24	28
10008577	75 x 2 1/2"	2	20	28
10008578	75 x 3"	2	18	24
10008587	90 x 2 1/2"	1	14	18
10008588	90 x 3"	1	13	15
10008589	90 x 4"	1	10	14
10008597	110 x 3"	1	8	11
10008598	110 x 4"	1	8	10



KABLİN DİŞİ

FEMALE ADAPTOR

МУФТА С ВНУТРЕН.РЕЗЬБ

راس خرطوم سن داخلی

PASLANMAZ METAL YÜZÜKLÜ (AISI430)

STAINLESS STEEL REINFORCEMENT RING

кольцом из нержавеющей стали

المجموعة الزرقاء الجديدة معدن

اء الجديدة معدن غير قابل لآ

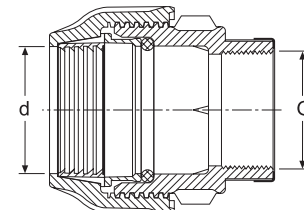

KOD CODE	EBAT/SIZE d x G	AMBALAJ ADEDİ PACKING QUANTITY	KOLİ ADEDİ BOX QUANTITY	ÇUVAL ADEDİ SACK QUANTITY
10007111	20 x ½"	50	700	750
10007112	20 x ¾"	50	550	650
10007121	25 x ½"	25	450	500
10007122	25 x ¾"	25	450	500
10007123	25 x 1"	25	350	400
10007132	32 x ¾"	25	275	300
10007133	32 x 1"	25	250	275
10007134	32 x 1 ¼"	25	225	250
10007143	40 x 1"	15	150	180
10007144	40 x 1 ¼"	15	150	165
10007145	40 x 1 ½"	15	135	150
10007154	50 x 1 ¼"	10	90	100
10007155	50 x 1 ½"	10	90	100
10007156	50 x 2"	10	80	90
10007165	63 x 1 ½"	6	54	60
10007166	63 x 2"	6	54	60
10007167	63 x 2 ½"	6	48	48
10007176	75 x 2"	4	32	36
10007177	75 x 2 ½"	4	32	32
10007178	75 x 3"	4	28	32
10007186	90 x 2"	4	16	20
10007187	90 x 2 ½"	4	16	20
10007188	90 x 3"	4	16	20
10007189	90 x 4"	4	12	16
10007195	110 x 2"	2	12	16
10007196	110 x 2 ½"	2	12	14
10007197	110 x 3"	2	12	14
10007198	110 x 4"	2	12	14



KABLİN DIŐİ TE

FEMALE TEE

ТРОЙНИК С ВНУТРЕН.РЕ.З.

تي خرطوم سن داخلي

PASLANMAZ METAL YÜZÜKLÜ (AISI430)

STAINLESS STEEL REINFORCEMENT RING

кольцом из нержавеющей стали

المجموعة الزرقاء الجديدة معدن

غير قابل للصدأ مع عصابة

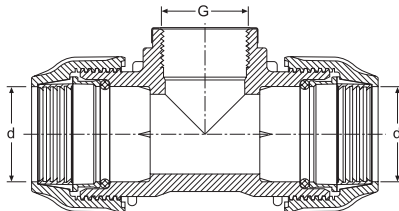

KOD CODE	EBAT/SIZE d x G x d	AMBALAJ ADEDİ PACKING QUANTITY	KOLİ ADEDİ BOX QUANTITY	ÇUVAL ADEDİ SACK QUANTITY
10007311	20 x 1/2" x 20	15	270	300
10007312	20 x 3/4" x 20	15	240	270
10007321	25 x 1/2" x 25	10	200	220
10007322	25 x 3/4" x 25	10	180	200
10007323	25 x 1" x 25	10	160	170
10007331	32 x 1/2" x 32	10	120	140
10007332	32 x 3/4" x 32	10	110	130
10007333	32 x 1" x 32	10	100	120
10007334	32 x 1 1/4" x 32	10	100	110
10007342	40 x 3/4" x 40	5	60	75
10007343	40 x 1" x 40	5	60	75
10007344	40 x 1 1/4" x 40	5	55	70
10007345	40 x 1 1/2" x 40	5	50	70
10007352	50 x 3/4" x 50	4	40	48
10007353	50 x 1" x 50	4	40	48
10007354	50 x 1 1/4" x 50	4	40	44
10007355	50 x 1 1/2" x 50	4	40	44
10007356	50 x 2" x 50	4	32	36
10007363	63 x 1" x 63	3	21	27
10007364	63 x 1 1/4" x 63	3	21	27
10007365	63 x 1 1/2" x 63	3	21	24
10007366	63 x 2" x 63	3	21	24
10007367	63 x 2 1/2" x 63	3	18	21
10007376	75 x 2" x 75	1	14	16
10007377	75 x 2 1/2" x 75	1	12	14
10007378	75 x 3" x 75	1	12	13
10007387	90 x 2 1/2" x 90	1	8	9
10007388	90 x 3" x 90	1	6	9
10007389	90 x 4" x 90	1	7	7
10007396	110 x 2 1/2" x 110	1	6	7
10007397	110 x 3" x 110	1	5	5
10007398	110 x 4" x 110	1	4	5

KOD CODE	EBAT/SIZE d x G	AMBALAJ ADEDİ PACKING QUANTITY	KOLİ ADEDİ BOX QUANTITY	ÇUVAL ADEDİ SACK QUANTITY
10007511	20 x 1/2"	25	550	600
10007512	20 x 3/4"	25	450	500
10007521	25 x 1/2"	15	360	390
10007522	25 x 3/4"	15	330	360
10007523	25 x 1"	15	270	300
10007532	32 x 3/4"	10	220	250
10007533	32 x 1"	10	180	220
10007534	32 x 1 1/4"	10	150	170
10007543	40 x 1"	5	120	130
10007544	40 x 1 1/4"	5	100	120
10007545	40 x 1 1/2"	5	90	100
10007554	50 x 1 1/4"	4	72	80
10007555	50 x 1 1/2"	4	60	68
10007556	50 x 2"	4	52	64
10007565	63 x 1 1/2"	4	40	52
10007566	63 x 2"	4	40	48
10007567	63 x 2 1/2"	4	32	40
10007576	75 x 2"	2	24	28
10007577	75 x 2 1/2"	2	20	28
10007578	75 x 3"	2	18	24
10007587	90 x 2 1/2"	1	14	18
10007588	90 x 3"	1	13	15
10007589	90 x 4"	1	10	14
10007597	110 x 3"	1	8	11
10007598	110 x 4"	1	8	10



KABLİN DIŞI DİRSEK

FEMALE ELBOW

ОТВОД С ВНУТРЕ.РЕЗ.

زاوية خرطوم سن داخلي

PASLANMAZ METAL YÜZÜKLÜ (AISI430)

STAINLESS STEEL REINFORCEMENT RING

кольцом из нержавеющей стали

المجموعة الزرقاء الجديدة معدن

غير قابل للصدأ مع عصابة

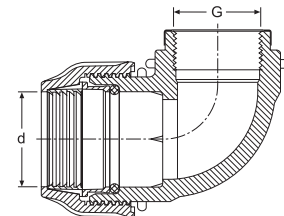



TAMİR MANŞONU

REPAIRING COUPLING
РЕМОУТ МУФТЫ

حلقة تقوية مجافنة

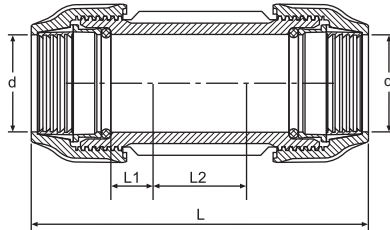

KOD CODE	EBAT SIZE	AMBALAJ ADEDİ PACKING QUANTITY	KOLİ ADEDİ BOX QUANTITY	ÇUVAL ADEDİ SACK QUANTITY	L	L ₁	L ₂
10009011	20	25	350	400	100	14.5	25
10009022	25	25	200	250	115	14.5	30
10009033	32	10	120	140	140	16.0	40
10009044	40	10	60	70	168	19.0	50
10009055	50	6	36	48	183	21.5	60
10009066	63	4	24	28	225	25.0	70
10009077	75	2	14	16	260	30.0	80
10009088	90	2	8	10	310	35.5	100
10009099	110	1	5	6	355	41.0	115



KABLİN ANAHTARI

FITTING SPANNER
СОЕДИНИТЕЛЬНЫЙ КЛЮЧ
الوصل مفتاح

KABLİN ANAHTAR (Fitting Spanner)

KOD CODE	EBAT SIZE	AMBALAJ ADEDİ PACKING QUANTITY	KOLİ ADEDİ BOX QUANTITY	ÇUVAL ADEDİ SACK QUANTITY
10009511	20	5	600	700
10009522	25	5	500	550
10009533	32	5	400	400
10009544	40	5	300	300
10009555	50	5	230	250
10009566	63	5	180	200
10009577	75	5	110	110
10009588	90	5	75	75
10009599	110	5	50	50

ISO 17885 STANDARDI - TESTLER / ISO 17885 STANDARD - TESTS

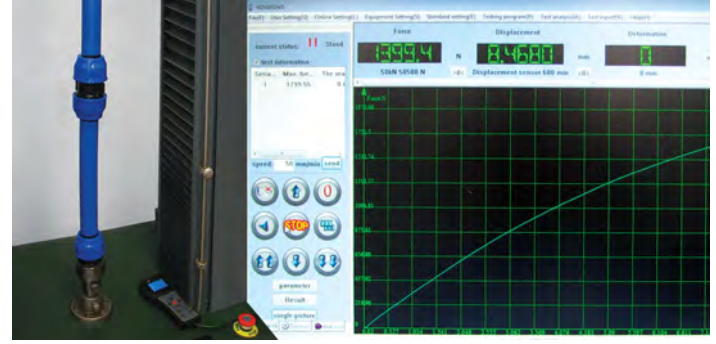

PLASTİK MALZEMENİN UZUN VADEDE DAVRANIŞININ DOĞRULANMASI
Ekleme parçalarının gövdeleri, ISO 1167-1 test standardına göre test edilmektedir.

VERIFICATION OF LONG-TERM BEHAVIOUR OF THE PLASTIC MATERIAL
Compression fittings bodies are tested according to the ISO 1167-1 test standard.

Malzeme Material	Test Sıcaklığı / °C Test Temperature	Test Süresi / Saat Test Duration / Hour	Test Basıncı / Bar Test Pressure PN 16
PP-B	20	1	40.64
	95	1.000	6.56
PP-H	20	1	53.28
	95	1.000	9.12

İÇ BASINÇ ALTINDA SIZDIRMAZLIK

Montajlanmış ekleme parçaları, ISO 3458 test standardına göre test edilmektedir.

LEAK TIGHTNESS UNDER INTERNAL PRESSURE

Assembled fittings are tested according to the ISO 3458 test standard.

Test Sıcaklığı / °C Test Temperature	Test Süresi / Saat Test Duration / Hour	Test Basıncı / Bar Test Pressure PN 16
20 ± 5	1	24.0



23 °C SICAKLIKTAKI AYRILMA DİRENCİ

PE boru ile montajlanmış ekleme parçaları, ISO 3501 test standardına göre test edilmektedir.

RESISTANCE TO PULL-OUT AT 23 °C : Compression fittings, assembled with PE pipes, are tested according to the ISO 3501 test standard.

PN 16 Grubu için Çekme Kuvveti (Newton) Pull Force for PN 16 Group (Newton)

Ø20	Ø25	Ø32	Ø40	Ø50	Ø63	Ø75	Ø90	Ø110
1.119	1.686	2.704	4.175	6.492	10.313	14.416	20.086	31.086

İÇ BASINÇ ALTINDA UZUN SÜRELİ SIZDIRMAZLIK

Montajlanmış ekleme parçaları, ISO 3458, ISO 1167-1, ISO 1167-4 test standardına göre test edilmektedir.

LONG-TERM PRESSURE TEST FOR LEAK TIGHTNESS UNDER INTERNAL PRESSURE
Assembled fittings are tested according to the ISO 3458, ISO 1167-4 test standards.

Test Sıcaklığı / °C Test Temperature	Test Süresi / Saat Test Duration / Hour	Test Basıncı / Bar Test Pressure PN 16
20	1.000	19.2

BÜKÜLÜ İKEN İÇ BASINÇ ALTINDA SIZDIRMAZLIK

Montajlanmış ekleme parçaları, ISO 3503 test standardına göre test edilmektedir.

LEAK TIGHTNESS UNDER INTERNAL PRESSURE WHEN SUBJECTED TO BENDING
Assembled fittings are tested according to the ISO 3503 test standard.

Test Sıcaklığı / °C Test Temperature	Test Süresi / Saat Test Duration / Hour	Test Basıncı / Bar Test Pressure PN 16
23 ± 2	1	24.0

DİŞLER Ekleme parçaları için dişler, ISO 7-1 standardına uygundur.

THREADS Threads for compression fittings are available for ISO 7-1 standard.

SU KALİTESİ ÜZERİNDEKİ ETKİSİ Ekleme parçaları, içme suyu üzerinde mikroorganizmaların çoğalmalarına izin vermemelidir. KIWA ve TSE kuruluşlarının laboratuvarları tarafından ilgili testler yapılarak raporlandırılmıştır.

INFLUENCE ON WATER QUALITY Compression fittings must not allow increasing microorganisms on drinking water. It was reported with the related tests by the laboratories of KIWA and TSE Institutions.

YENİ MAVİ SERİ

New Blue Series Compression Fittings

Новая Синяя Серия

المجموعة الزرقاء الجديدة

Dikkat Edilmesi Gereken Hususlar

- + Poelsan boru bağlantı adaptörleri depolama ve montaj esnasında sert ve keskin cisimlerden uzak tutulmalıdır. Tesisat toprak altına dönecekse, sert ve keskin cisimlerden korumak amacıyla kum ile kapatılmalıdır. Kesinlikle hasar görmüş adaptörler kullanılmamalıdır.
- + Poelsan boru bağlantı adaptörlerinden maksimum verim alabilmek için, te ve dirsekler 90°, diğer adaptörler 180° açı yapacak şekilde boruya monte edilmelidir. Değişik açılar oluşturan bağlantılar adaptör üzerinde gerilmelere neden olacağından tesisatın ömrü azalacaktır.
- + Dişli bağlantılarda teflon bant kullanılmalıdır. Teflon bant adaptöre su sızıntısını önleyecek kadar ve sıkma yönünde sarılmalıdır.
- + Montaj esnasında somunun fazla sıkılması adaptör üzerinde ek bir gerilmeye neden olur. Bu şekilde ek bir gerilmeye maruz kalmış olan ürünün garanti verilen basınç değerlerini karşılaması beklenemez. Bu nedenle ürünün plastik olduğu ve sadece sızdırmazlığı sağlayacak kuvvette sıkılması gerektiği unutulmamalıdır.

Points to Take Into Consideration

- + Poelsan compression fittings should be kept away from hard or sharp objects during storage or installation phases. If the installation will be under the ground, it should be covered with sand in order to keep away from contact with hard and sharp objects. Damaged fittings shouldn't be used strictly.
- + To be able to get the best efficiency from Poelsan compression fittings, tee and elbow pieces should be joined with 90°, other fittings should be joined with 180° to the system. The installation with different angles will make extra tensile on the fittings and will decrease the lifetime of the system.
- + Teflon band should be used with the threaded pieces. The band should be used enough to prevent water leakage and wrapped on the threaded part in the twisting direction.
- + Over twisting of the nut will cause extra tension on the adaptor. A nut, which is exposed to such an extra tension cannot provide the guaranteed pressure value. Therefore the user should remember that the material is plastic and the nut should be twisted with a force only enough to prevent leakage.

NEW BLUE SERIES

Yeni Mavi Seri

Новая Синяя Серия

المجموعة الزرقاء الجديدة

Tesisatın Son Kontrolü

GÖZLE KONTROL

Tesisatın döşenmesi sırasında hasar görmüş adaptörlerin tespiti için mutlaka adaptörler gözle kontrol edilmelidir.

SIZDIRMAZLIK KONTROLÜ

Tesisatın montajı sonrasında tesisata mutlaka test basıncında su verilmeli ve sızdırmazlık durumu tespit edilmelidir.

SIZINTIYA NEDEN OLABİLECEK UYGULAMALAR

Poelsan boru bağlantı adaptörlerinin dış ölçüleri standartlara uygun olarak üretilmiştir.

- Kullanılan diğer metal ya da plastik malzemenin uygun olmaması,
- Teflon bandın yeterli miktarda kullanılmaması,
- Ürünün aşırı miktarda sıkılması ya da montaj esnasında düzgün monte edilmemesi sonucu ürünün dişlerinin bozulması,
- Montaj esnasında boruya pah açılmaması ve bu nedenle oringin zarar görmesi ya da oringin yerinden çıkması,
- Borulardaki ovalliğin verilen tolerans değerlerinden (± 0.5 mm) daha farklı olması,
- Somunun yanlış monte edilmesi, yeterli miktarda sıkılmaması ya da çok fazla sıkılarak ürünün çatlaması,
- Boru tutucunun oring tutucu ile birleştirilmeden somunun sıkılarak adaptörün montajının yapılması, tesisatınızda sızıntıya neden olabilir.

Final Check of the Installation

VISUAL CHECK

During installation, the system should be checked visually in order to determine the damaged adaptors.

LEAKPROOFNESS CHECK

After the installation, the system should be checked with water in testing pressure to determine the water leak.

CONDITIONS THAT MAY CAUSE LEAKAGE

The measurements of the threads of Poelsan compression fittings are produced according to the standards.

- Unfitness of the measurements of the threads of other metal or plastic material,
- Unefficient use of the teflon band,
- Spoiling of the threads because of the improper installation or over twisting of the nut,
- Using unchamfered pipes and causing damage on the o-ring or removing the o-ring,
- Excess of ovality off the pipes different than the tolerance values (± 0.5 mm),
- Wrong installation, inefficient twisting or cracking the nut by over twisting,
- Twisting the nut and installing the adaptor without joining the locking ring and the o-ring holder, may cause leaks in the system.

ADAPTÖRLERİN MONTAJ YÖNTEMLERİ / INSTALLATION METHODS

(Ø20, Ø25, Ø32, Ø40, Ø50, mm adaptörler / adaptors)

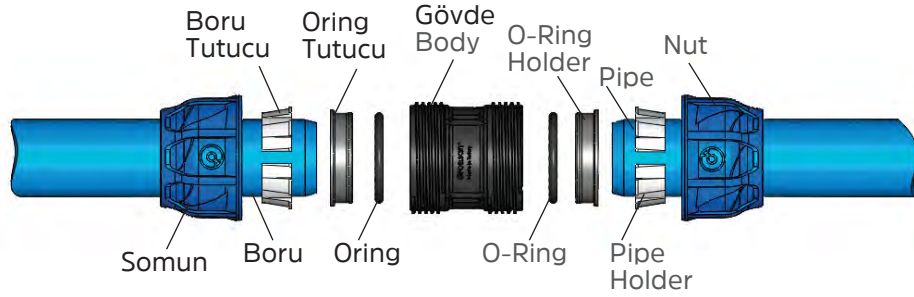

MONTAJ YÖNTEMİ / INSTALLATION METHOD

- 1 Boru uçlarına yaklaşık 15° pah açınız.**
Make chamfer on the pipe ends.
(Approximately 15°)



- 2 Boru üzerini, borunun adaptöre geçiş mesafesine göre işaretleyiniz.**
Mark the pipe, according to the pipe end point inside the fitting.



- 3 Adaptörünüzün somununu yaklaşık 3 tam tur döndürüp gevşetiniz.**
Untwist 3 full rounds and loosen the nut of the fitting.



- 4 Boruyu, adaptörünüzün iç kısmındaki * boru dayanma noktasına kadar iyice itiniz.**
Push the pipe to * the pipe end point inside the fitting.

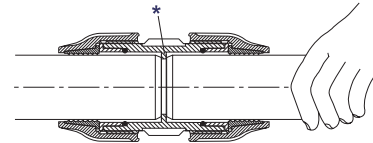

ADAPTÖRLERİN MONTAJ YÖNTEMLERİ / HOW TO INSTALL THE FITTINGS

(Ø63, Ø75, Ø90, Ø110, mm adaptörler / adaptors)

I MONTAJ YÖNTEMİ / INSTALLATION METHOD

1 Pah açmaya gerek yoktur.

There is no need to make chamfer on the pipe end.

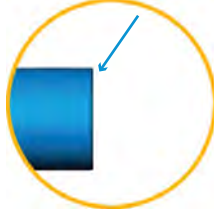

3 Boruya sırasıyla; önce somunu, sonra oring tutucu ve oringi takınız.

Place the nut, o-ring holder and the o-ring on the pipe respectively.



5 Somunu sıkarak adaptörünüzle birleştiriniz. Bu işlem oring ve oring tutucunun kolayca takılmasını sağlayacaktır.

Twist the nut till it is attached to the fitting. This will help the o-ring and the o-ring holder to be placed easily.



7 Boru tutucuyu borunun çapı kadar esneterek boruya takınız. Boru üzerinde kaydırarak oring tutucu ile birleştiriniz.

Stretch the locking ring to the diameter of the pipe. Place it on the pipe by sliding it to the o-ring holder.

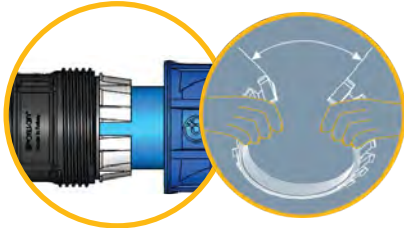

2 Boru üzerini, borunun adaptöre geçiş mesafesine göre işaretleyiniz.

Mark the pipe, according to the pipe end point inside the fitting.



4 Boruyu, adaptörünüzün iç kısmındaki * boru dayanma noktasına kadar iyice itiniz.

Push the pipe to * the pipe end point inside the fitting.

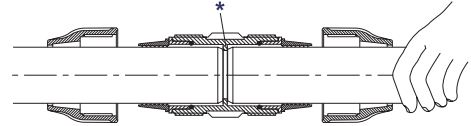

6 Somunu gevşeterek açınız.

Untwist and loosen the nut from the fitting.



8 Somunu Poelsan Kablin Anahtarı ile sıkınız.

Twist the nut with Poelsan Fitting Spanner.



SERTİFİKALARIMIZ / CERTIFICATES



MARKA TESCİL BELGESİ
BRAND REGISTRATION



KALİTE YÖNETİM BELGESİ
QUALITY MANAGEMENT
SYSTEM CERTIFICATE



ÇEVRE YÖNETİM BELGESİ
ENVIRONMENT MANAGEMENT
SYSTEM CERTIFICATE



İŞ SAĞLIĞI GÜVENLİĞİ
OCCUPATIONAL HEALTH &
SAFETY MANAGEMENT
SYSTEM CERTIFICATE



**YENİ MAVİ SERİ
AMERİKA PATENTİ**
NEW BLUE SERIES
USA DESIGN PATENT



KIWA BELGESİ
KIWA CERTIFICATE



**MAVİ SERİ TASARIM
TESCİL BELGESİ**
BLUE SERIES
DESIGN REGISTRATION
CERTIFICATE



**YENİ MAVİ SERİ TASARIM
TESCİL BELGESİ**
NEW BLUE SERIES
DESIGN REGISTRATION
CERTIFICATE



**YENİ PRİZ KOLYE TASARIM
TESCİL BELGESİ**
NEW CLAMP SADDLE
DESIGN REGISTRATION
CERTIFICATE



FAYDALI MODEL BELGESİ
UTILITY MODEL CERTIFICATE
FLEXIBLE O-RING HOLDERS



**TS ISO 17885 ÇİFT YILDIZ
KRİTERLERİNE UYGUNLUK**
TSE ISO 17885 CERTIFICATE
of CONFORMITY to
DOUBLE STAR CRITERIA

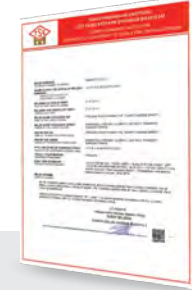

**TS ISO 13460-1 ÇİFT YILDIZ
KRİTERLERİNE UYGUNLUK**
TSE ISO 13460-1 CERTIFICATE
of CONFORMITY to
DOUBLE STAR CRITERIA



**TS ISO 17885 TÜRK
STANDARTLARINA UYGUNLUK**
TSE ISO 17885 CERTIFICATE of
CONFORMITY to TSE



**TS ISO 13460-1 TÜRK
STANDARTLARINA UYGUNLUK**
TSE ISO 13460-1 CERTIFICATE
of CONFORMITY to TSE



**TS 13716 VANA KUTULARI
TÜRK STANDARTLARINA UYGUNLUK**
TS 13716 VALVE BOXES CERTIFICATE
of CONFORMITY to TSE



**TS ISO 9911 VANALAR TSE
KRİTERLERİNE UYGUNLUK**
TS ISO 9911 VALVES CERTIFICATE
of CONFORMITY to TSE



**TS ISO 9261 TÜRK
STANDARTLARINA UYGUNLUK**
TS ISO 9261 CERTIFICATE of
CONFORMITY to TSE

SERTİFİKALARIMIZ / CERTIFICATES



NOTLAR / NOTES

NOTLAR / NOTES

Blank lined area for notes, consisting of 15 horizontal gray bars.

NOTLAR / NOTES

NOTLAR / NOTES

NOTLAR / NOTES



07/2019

Şabanoğlu OSB Mahallesi Ulubatlı Caddesi No: 6 Tekkeköy SAMSUN TÜRKİYE
Tel: +90 362 266 75 24 Faks: +90 362 266 77 51 GSM: +90 544 366 69 64

www.poelsan.com |    poelsan |   poelsanplastik | poelsan@poelsan.com