



POELSAN®



YEŞİL SERİ ÜRÜN KATALOĞU

GREEN SERIES PRODUCTION CATALOGUE



Poelsan Dünya Firmalarıyla Rekabet Ediyor...

+ Poelsan, 1994 yılında henüz ülkemizde üretimi yapılmadığı için ithal edilen Polietilen Kangal Boru Bağlantı Adaptörlerini, kendi tesisinde üreterek piyasaya sunan ilk firma olmuştur.

Poelsan ürünleri, başta peyzaj sektörü olmak üzere, içme suyu şebekelerinde, tarım alanlarında, seralarda, damla sulama sistemlerinde güvenle kullanılabilir. Poelsan ürünleri, başta peyzaj sektörü olmak üzere, içme suyu şebekelerinde, tarım alanlarında, seralarda, damla sulama sistemlerinde güvenle kullanılabilir.

Poelsan, 52.000 m² alanda yıllık 10.522 ton plastik işleme kapasitesiyle üretim yapmaktadır. Poelsan, yurt içinde tüm illere yayılmış yaklaşık 400 bayi ile çalışmakta ve 60 ülkeye ihracat yapmaktadır.

Poelsan, 2.000'in üzerinde ürün çeşidine sahiptir ve sektördeki yeniliklere bağlı olarak mevcut ürün çeşidini sürekli olarak arttırmayı ve sektöründe bir dünya markası olmayı hedeflemektedir.

Poelsan is in the Global Market...

+ Poelsan is the first company that produced and marketed the Compression Fittings for PE Roll Pipes at its own plant, as the mentioned products cannot be produced in the country and consequently been imported up to the year 1994.

Our products can be used safely in the areas of landscaping, potable water networks, agricultural irrigation, drip irrigation and greenhouses.

Poelsan makes production in 52.000 m² area with its annual plastic process of 10.522 tones. Poelsan cooperates with 400 domestic distributors overall provinces in Turkey and also exports to 60 countries presently.

Poelsan has a wide product range consisting of more than 2.000 items and our company aims to extend its current product range consistently depending on the developments in the sector and to be a global brand.



Misyonumuz

- + Yüksek kalite ve teknolojinin buluşması ile plastik boru ek parça üretiminde yerel ve küresel pazarda öncü bir marka olmak.

Vizyonumuz

- + Plastik boru bağlantı sistemlerinde yakın coğrafyada lider, global pazarda tercih edilen bir marka olmak.

Değerlerimiz

- + İnsan ve Çevreye Saygı
- + Liderlik
- + Güvenilirlik
- + Değerli Hissettirmek
- + Gelişime ve Yeniliğe Açık
- + Takım Ruhu

Our Mission

- + To be a leading brand in the local and global market in the production of plastic pipe fittings with the combination of high quality and technology.

Our Vision

- + To become the leader in the nearby geography in plastic pipe connection systems, and a preferred brand in global market.

Our Values

- + Respect for Human and Environment
- + Leadership
- + Reliability
- + Making Feel Special
- + Open for Development and Innovation
- + Team Spirit



SEKTÖRÜNDE DÜNYA MARKASI

WORLD'S LEADING BRAND IN THE INDUSTRY



65 2.000 Üzerinde **Ürün Çeşidi**
ÜLKEYE İHRACAT

More than 2.000 products range
in 65 countries

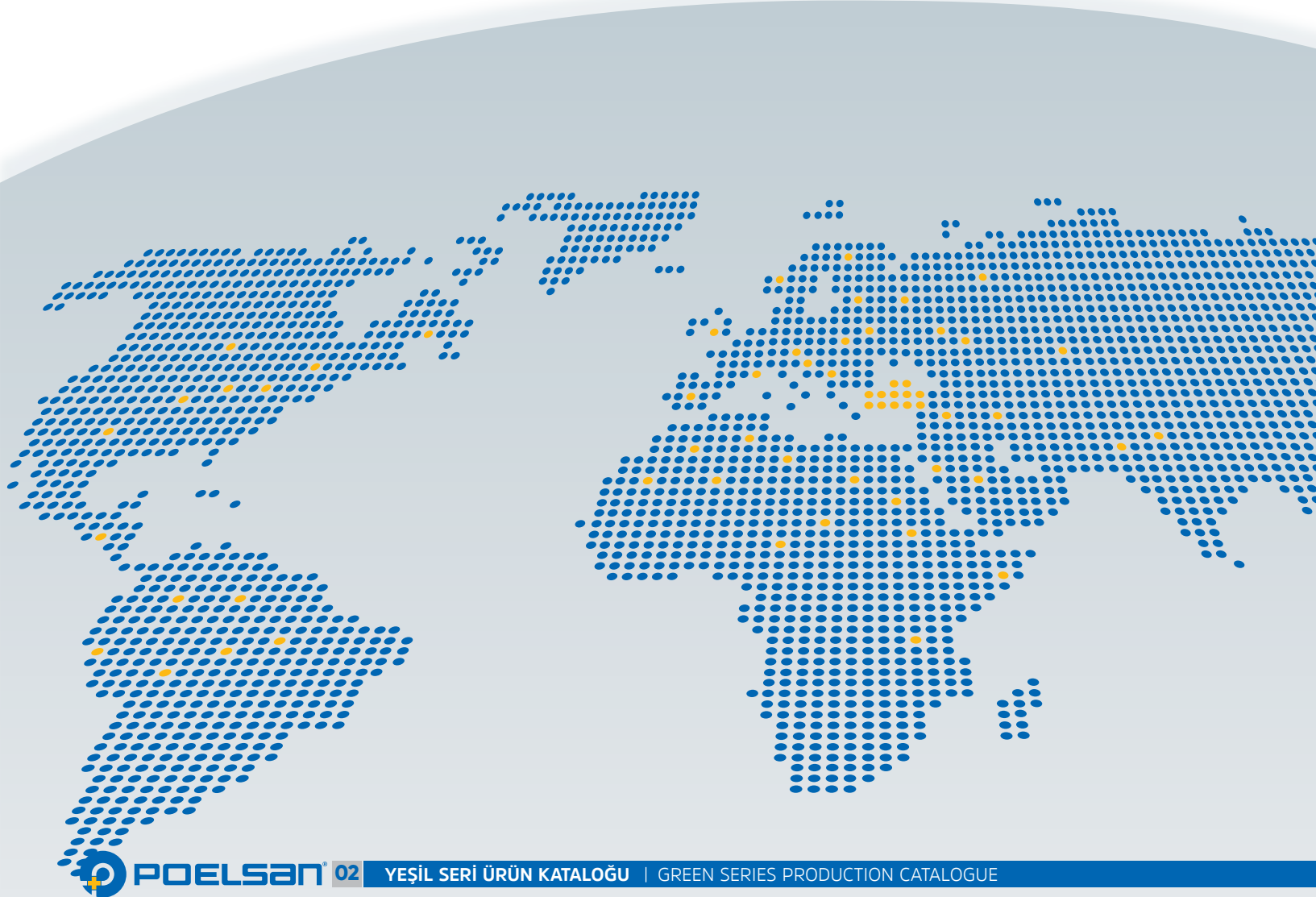

ALMANYA + ARJANTİN + ARNAVUTLUK + AVUSTRALYA + AZERBAYCAN + BELARUS
BOLİVYA + BREZİLYA + BULGARİSTAN + BOSNA HERSEK + CEZAYİR
ÇEK CUMHURİYETİ + EKVADOR + ERMENİSTAN + ETİYOPYA + FAS + FİLİSTİN
FRANSA + GÜRCİSTAN + HIRVATİSTAN + HİNDİSTAN + HOLLANDA + IRAK + İNGİLTERE
İRAN + İRLANDA + İSPANYA + İSRAİL + İTALYA + KARADAĞ + KATAR + KAZAKİSTAN
K.K.T.C + KOSOVA + KOSTA RİKA + KUVEYT + LETONYA + LİBYA + LÜBNAN
MACARİSTAN + MISIR + MOLDOVA + NORVEÇ + ÖZBEKİSTAN + PAKİSTAN
PERU + POLONYA + PORTEKİZ + ROMANYA + RUSYA + SIRBİSTAN + SURİYE
SUUDİ ARABİSTAN + SLOVAKYA + ŞİLİ + TAYLAND + TUNUS + TÜRKMENİSTAN
UKRAYNA + URUGUAY + ÜRDÜN + VENEZUELA + YEMEN + YENİ ZELANDA + YUNANİSTAN
ALBANIA + ALGERIA + ARGENTINA + ARMENIA + AUSTRALIA + AZERBAIJAN + BELARUS
BOLIVIA + BRAZIL + BULGARIA + BOSNIA AND HERZEGOVINA + CHILE + CZECH + REPUBLIC
+ CROATIA + COSTA RICA + ECUADOR + EGYPT + ENGLAND + ETHIOPIA + FRANCE
GEORGIA + GERMANY + GREECE + HOLLAND + HUNGARY + INDIA + IRAN + IRELAND + IRAQ
+ ISRAEL + ITALY + JORDAN + KAZAKHSTAN + KOSOVO + KUWAIT + LATVIA
LEBANON + LIBYA + MOLDOVA + MONTENEGRO + MOROCCO
NEW ZEALAND + NORWAY + PAKISTAN + PALESTINE
PERU + POLAND + PORTUGAL + QATAR + ROMANIA
RUSSIA + SLOVAKIA + SAUDI ARABIA
SERBIA + SPAIN + SYRIA + THAILAND
TUNISIA + TURKMENISTAN
T.R.N.C + UZBEKISTAN
UKRAINE + URUGUAY
VENEZUELA
+ YEMEN

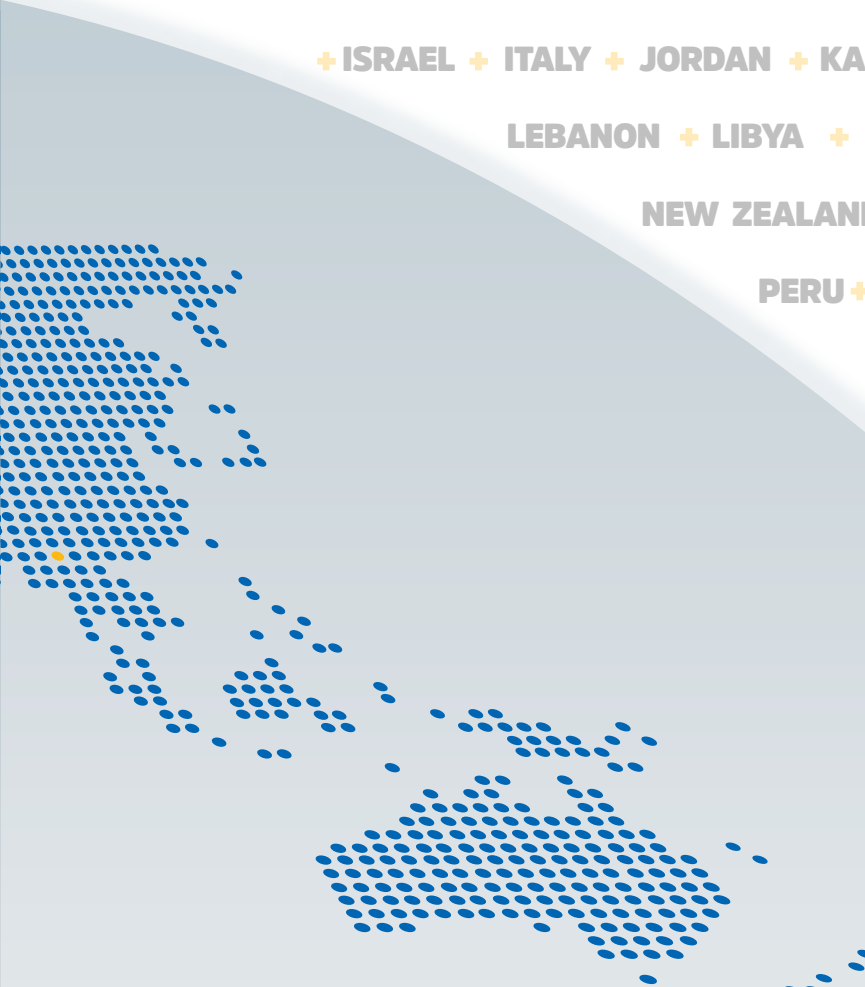

YEŞİL SERİ

GREEN SERIES

Зеленая серия

السلسلة الخضراء

Özellikler

- + Darbelere karşı dayanıklı, yüksek kaliteli polipropilen hammaddeden üretilmiştir.
- + Borulardaki ± 0.5 mm'ye kadar olan ölçü farklılıklarından veya ovalikten oluşabilecek sorunları konik sıkma özelliği sayesinde önler.
- + UV ışınlarını geçirmediği için yosunlanmaya ve bakteri üremesine izin vermez.
- + Oringi tabii kauçuktan üretilmekte olup yüksek sızdırmazlık sağlar.
- + İç yüzeyleri homojen ve gözeneksizdir.
- + Suyun kokusunu ve tadını değiştirebilecek hiçbir yabancı madde içermez.

Specifications

- + It has been produced from high quality polypropylene raw material and it has resistance to impact.
- + Due to conical tightening, they remove faults in pipes that may be caused by dimensional differences and ovality up to ± 0.5 mm.
- + They prevent alga and bacteria forming due to UV proof (ultraviolet beam) structure.
- + O-rings are made of natural rubber and provide high leakproofness.
- + It has a homogeneous and non-porous inner surface.
- + It does not contain any foreign substance which can change the taste or the smell of the water.



TS ISO 17885

GARANTİ VERİLEN BASINÇ DEĞERLERİ

GUARANTEED PRESSURE VALUES

Ø 20 mm – Ø 63 mm: PN 10

Ø 75 mm – Ø 110 mm: PN 6

KULLANIM ALANLARI

- + Şehir Şebekesi İçme Suyu
- + Peyzaj Sektörü
- + Tarımsal Sulama
- + Seralar

INSTALLATION AREAS

- + Urban Potable Water Networks
- + Landscaping Systems
- + Agricultural Irrigation
- + Greenhouses



YEŞİL SERİ / GREEN SERIES COMPRESSION FITTINGS

KOD CODE	EBAT / SIZE d x G	AMBALAJ ADEDİ PACKING QUANTITY	KOLİ ADEDİ BOX QUANTITY	ÇUVAL ADEDİ SACK QUANTITY
7111	20 x 1/2"	50	650	700
7112	20 x 3/4"	50	600	700
7121	25 x 1/2"	25	450	450
7122	25 x 3/4"	25	400	450
7123	25 x 1"	25	400	450
7131	32 x 1/2"	25	250	300
7132	32 x 3/4"	25	250	300
7133	32 x 1"	25	250	275
7134	32 x 1 1/4"	25	225	250
7143	40 x 1"	15	150	165
7144	40 x 1 1/4"	15	135	150
7145	40 x 1 1/2"	15	120	150
7154	50 x 1 1/4"	10	90	100
7155	50 x 1 1/2"	10	90	100
7156	50 x 2"	10	80	100
7165	63 x 1 1/2"	6	60	66
7166	63 x 2"	6	60	66
7167	63 x 2 1/2"	6	54	60
7176	75 x 2"	4	36	40
7177	75 x 2 1/2"	4	32	36
7178	75 x 3"	4	28	36
7187	90 x 2 1/2"	4	20	20
7188	90 x 3"	4	20	20
7189	90 x 4"	4	20	20
7198	110 x 3"	2	12	16
7199	110 x 4"	2	12	16

KOD CODE	EBAT / SIZE d x G	AMBALAJ ADEDİ PACKING QUANTITY	KOLİ ADEDİ BOX QUANTITY	ÇUVAL ADEDİ SACK QUANTITY
7211	20 x 1/2"	50	600	650
7212	20 x 3/4"	50	550	600
7221	25 x 1/2"	25	450	475
7222	25 x 3/4"	25	400	450
7223	25 x 1"	25	350	375
7232	32 x 3/4"	25	225	250
7233	32 x 1"	25	200	250
7234	32 x 1 1/4"	25	200	200
7243	40 x 1"	15	135	150
7244	40 x 1 1/4"	15	135	135
7245	40 x 1 1/2"	15	120	135
7254	50 x 1 1/4"	10	80	90
7255	50 x 1 1/2"	10	80	90
7256	50 x 2"	10	80	90
7265	63 x 1 1/2"	6	54	54
7266	63 x 2"	6	54	60
7267	63 x 2 1/2"	6	54	54
7276	75 x 2"	4	32	36
7277	75 x 2 1/2"	4	32	32
7278	75 x 3"	4	28	32
7287	90 x 2 1/2"	4	20	20
7288	90 x 3"	4	20	20
7289	90 x 4"	4	20	20
7298	110 x 3"	2	12	14
7299	110 x 4"	2	12	14



KABLİN ERKEK
MALE ADAPTOR
МУФТА С НАРУЖН. РЕ
س خرطوم سن خارجي

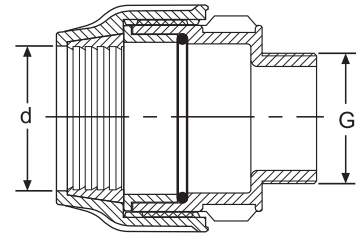

KABLİN DIŞI
FEMALE ADAPTOR
МУФТА С ВНУТРЕН. РЕЗБ
راس خرطوم سن داخلي

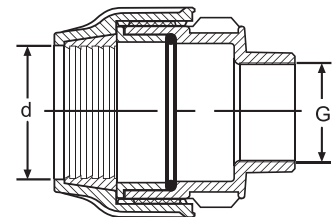

السلسلة الخضراء / ЗЕЛЕНАЯ СЕРИЯ



KABLİN MANŞON
COUPLING

МУФТА СОЕДИНИТЕЛЬНАЯ

وصلة خرطوم

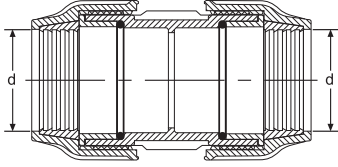

KOD CODE	EBAT / SIZE d x d	AMBALAJ ADEDİ PACKING QUANTITY	KOLİ ADEDİ BOX QUANTITY	ÇUVAL ADEDİ SACK QUANTITY
7311	20 x 20	25	400	400
7322	25 x 25	25	250	250
7333	32 x 32	10	150	150
7344	40 x 40	10	100	90
7355	50 x 50	6	54	60
7366	63 x 63	5	35	35
7377	75 x 75	2	18	20
7388	90 x 90	2	12	14
7399	110 x 110	1	7	8



KABLİN TE

TEE

ТРОЙНИК

تي خرطوم

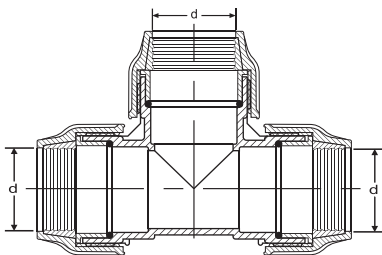

KOD CODE	EBAT / SIZE d x d x d	AMBALAJ ADEDİ PACKING QUANTITY	KOLİ ADEDİ BOX QUANTITY	ÇUVAL ADEDİ SACK QUANTITY
7611	20 x 20 x 20	15	210	225
7622	25 x 25 x 25	10	140	150
7633	32 x 32 x 32	5	80	90
7644	40 x 40 x 40	5	50	50
7655	50 x 50 x 50	4	28	32
7666	63 x 63 x 63	3	18	18
7677	75 x 75 x 75	1	11	12
7688	90 x 90 x 90	1	7	7
7699	110 x 110 x 110	1	4	5

YEŞİL SERİ / GREEN SERIES COMPRESSION FITTINGS

KOD CODE	EBAT / SIZE d x G x d	AMBALAJ ADEDİ PACKING QUANTITY	KOLİ ADEDİ BOX QUANTITY	ÇUVAL ADEDİ SACK QUANTITY
7711	20 x 1/2" x 20	15	270	300
7712	20 x 3/4" x 20	15	270	300
7721	25 x 1/2" x 25	10	200	200
7722	25 x 3/4" x 25	10	180	200
7723	25 x 1" x 25	10	180	180
7724	25 x 1 1/4" x 25	10	140	160
7732	32 x 3/4" x 32	10	110	120
7733	32 x 1" x 32	10	100	120
7734	32 x 1 1/4" x 32	10	100	100
7743	40 x 1" x 40	5	60	75
7744	40 x 1 1/4" x 40	5	50	70
7745	40 x 1 1/2" x 40	5	50	60
7753	50 x 1" x 50	4	40	48
7754	50 x 1 1/4" x 50	4	40	44
7755	50 x 1 1/2" x 50	4	36	44
7756	50 x 2" x 50	4	36	40
7764	63 x 1 1/4" x 63	3	27	30
7765	63 x 1 1/2" x 63	3	27	30
7766	63 x 2" x 63	3	24	27
7767	63 x 2 1/2" x 63	3	21	21
7776	75 x 2" x 75	1	18	18
7777	75 x 2 1/2" x 75	1	13	17
7778	75 x 3" x 75	1	12	15
7787	90 x 2 1/2" x 90	1	9	11
7788	90 x 3" x 90	1	9	10
7789	90 x 4" x 90	1	9	9
7798	110 x 3" x 110	1	5	6
7799	110 x 4" x 110	1	5	6

KOD CODE	EBAT / SIZE d x G x d	AMBALAJ ADEDİ PACKING QUANTITY	KOLİ ADEDİ BOX QUANTITY	ÇUVAL ADEDİ SACK QUANTITY
7811	20 x 1/2" x 20	15	270	300
7812	20 x 3/4" x 20	15	240	240
7821	25 x 1/2" x 25	10	180	200
7822	25 x 3/4" x 25	10	180	200
7823	25 x 1" x 25	10	160	160
7831	32 x 1/2" x 32	10	110	120
7832	32 x 3/4" x 32	10	110	120
7833	32 x 1" x 32	10	100	120
7834	32 x 1 1/4" x 32	10	80	90
7842	40 x 3/4" x 40	5	60	75
7843	40 x 1" x 40	5	60	65
7844	40 x 1 1/4" x 40	5	60	60
7845	40 x 1 1/2" x 40	5	50	55
7852	50 x 3/4" x 50	4	44	48
7853	50 x 1" x 50	4	44	48
7854	50 x 1 1/4" x 50	4	40	44
7855	50 x 1 1/2" x 50	4	36	44
7856	50 x 2" x 50	4	28	36
7863	63 x 1" x 63	3	24	30
7864	63 x 1 1/4" x 63	3	24	30
7865	63 x 1 1/2" x 63	3	24	27
7866	63 x 2" x 63	3	24	24
7867	63 x 2 1/2" x 63	3	21	21
7876	75 x 2" x 75	1	13	16
7877	75 x 2 1/2" x 75	1	13	16
7878	75 x 3" x 75	1	12	13
7887	90 x 2 1/2" x 90	1	9	10
7888	90 x 3" x 90	1	9	10
7889	90 x 4" x 90	1	8	9
7898	110 x 3" x 110	1	5	6
7899	110 x 4" x 110	1	4	6



KABLİN ERKEK TE
MALE TEE
ТРОЙНИК С НАРУЖН.РЕ.З.
تی خرطوم سن خارجی

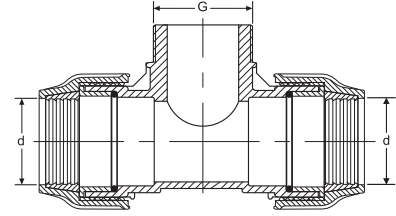

KABLİN DIŞİ TE
FEMALE TEE
ТРОЙНИК С ВНУТРЕН.РЕ.З.
تی خرطوم سن داخلی

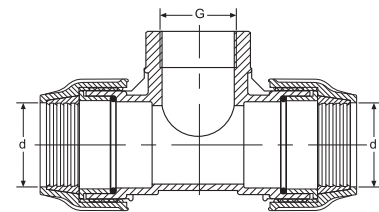

السلسلة الخضراء / Зеленая серия

YEŞİL SERİ / GREEN SERIES COMPRESSION FITTINGS

السلسلة الخضراء / ЗЕЛЕНАЯ СЕРИЯ



KABLİN DİRSEK

ELBOW

ОТВОД

زاوية خرطوم

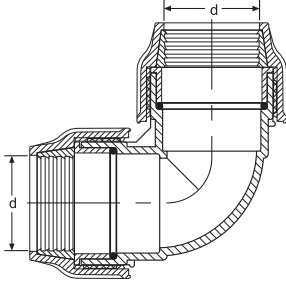

KOD CODE	EBAT / SIZE d x d	AMBALAJ ADEDİ PACKING QUANTITY	KOLİ ADEDİ BOX QUANTITY	ÇUVAL ADEDİ SACK QUANTITY
8111	20 x 20	25	350	375
8122	25 x 25	15	225	240
8133	32 x 32	10	130	140
8144	40 x 40	5	75	80
8155	50 x 50	4	44	52
8166	63 x 63	4	28	32
8177	75 x 75	2	14	20
8188	90 x 90	1	10	12
8199	110 x 110	1	5	7



KABLİN ERKEK DİRSEK

MALE ELBOW

ОТВОД С НАРУЖН. РЕЗ.

زاوية خرطوم سن خارجي

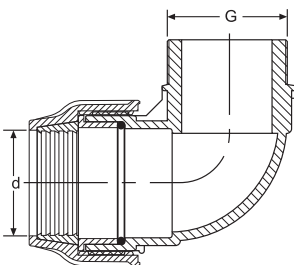

KOD CODE	EBAT / SIZE d x G	AMBALAJ ADEDİ PACKING QUANTITY	KOLİ ADEDİ BOX QUANTITY	ÇUVAL ADEDİ SACK QUANTITY
8211	20 x 1/2"	25	550	600
8212	20 x 3/4"	25	450	500
8221	25 x 1/2"	15	360	390
8222	25 x 3/4"	15	330	375
8223	25 x 1"	15	300	300
8232	32 x 3/4"	10	200	230
8233	32 x 1"	10	180	230
8234	32 x 1 1/4"	10	160	200
8243	40 x 1"	5	120	130
8244	40 x 1 1/4"	5	110	125
8245	40 x 1 1/2"	5	100	125
8254	50 x 1 1/4"	4	90	80
8255	50 x 1 1/2"	4	80	80
8256	50 x 2"	4	80	72
8265	63 x 1 1/2"	4	40	52
8266	63 x 2"	4	40	48
8267	63 x 2 1/2"	4	36	40
8276	75 x 2"	2	26	30
8277	75 x 2 1/2"	2	24	28
8278	75 x 3"	2	22	24
8287	90 x 2 1/2"	1	17	20
8288	90 x 3"	1	16	20
8289	90 x 4"	1	13	16
8298	110 x 3"	1	9	12
8299	110 x 4"	1	9	12

YEŞİL SERİ / GREEN SERIES COMPRESSION FITTINGS

KOD CODE	EBAT / SIZE d x G	AMBALAJ ADEDİ PACKING QUANTITY	KOLİ ADEDİ BOX QUANTITY	ÇUVAL ADEDİ SACK QUANTITY
8311	20 x 1/2"	25	500	550
8312	20 x 3/4"	25	400	400
8321	25 x 1/2"	15	360	390
8322	25 x 3/4"	15	300	360
8323	25 x 1"	15	240	270
8332	32 x 3/4"	10	200	220
8333	32 x 1"	10	180	200
8334	32 x 1 1/4"	10	140	170
8343	40 x 1"	5	120	125
8344	40 x 1 1/4"	5	100	115
8345	40 x 1 1/2"	5	90	100
8354	50 x 1 1/4"	4	64	80
8355	50 x 1 1/2"	4	64	80
8356	50 x 2"	4	56	64
8365	63 x 1 1/2"	4	44	52
8366	63 x 2"	4	40	48
8367	63 x 2 1/2"	4	36	40
8376	75 x 2"	2	24	28
8377	75 x 2 1/2"	2	24	28
8378	75 x 3"	2	24	28
8387	90 x 2 1/2"	1	17	20
8388	90 x 3"	1	17	18
8389	90 x 4"	1	13	15
8398	110 x 3"	1	9	10
8399	110 x 4"	1	8	10

KOD CODE	EBAT / SIZE d x d ₁ x d	AMBALAJ ADEDİ PACKING QUANTITY	KOLİ ADEDİ BOX QUANTITY	ÇUVAL ADEDİ SACK QUANTITY
8612	20 x 25 x 20	10	160	200
8621	25 x 20 x 25	10	160	170
8623	25 x 32 x 25	10	100	120
8631	32 x 20 x 32	5	100	110
8632	32 x 25 x 32	5	90	100
8642	40 x 25 x 40	5	60	65
8643	40 x 32 x 40	5	50	65
8652	50 x 25 x 50	4	40	44
8653	50 x 32 x 50	4	40	40
8654	50 x 40 x 50	4	32	36
8663	63 x 32 x 63	3	24	30
8664	63 x 40 x 63	3	21	27
8665	63 x 50 x 63	3	24	24
8675	75 x 50 x 75	1	14	16
8676	75 x 63 x 75	1	12	14
8686	90 x 63 x 90	1	8	10
8687	90 x 75 x 90	1	8	8
8698	110 x 90 x 110	1	4	5



KABLİN DIŞI DİRSEK

FEMALE ELBOW

ОТВОД С ВНУТРЕ.РЕЗ.

زاوية خرطوم سن داخلي

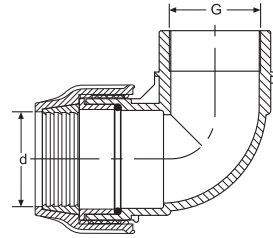

KABLİN REDÜKSİYON TE

REDUCING TEE

ТРОЙНИК ПЕРЕХОДНОЙ

تي خرطوم محول

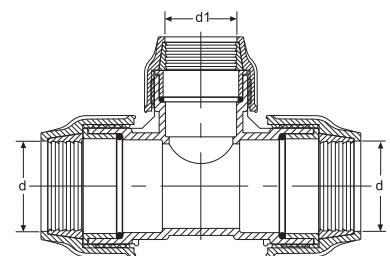

السلسلة الخضراء / ЗЕЛЕНАЯ СЕРИЯ

YEŞİL SERİ / GREEN SERIES COMPRESSION FITTINGS

السلسلة الخضراء / Зелёная серия



KABLİN REDÜKSİYON MANŞON

REDUCING COUPLING

ПЕРЕХОДНИК

وصلة خرطوم محول

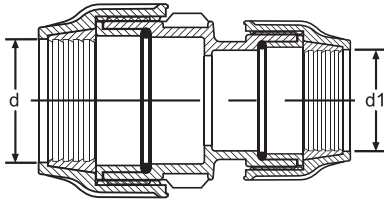

KOD CODE	EBAT / SIZE d x d ₁	AMBALAJ ADEDİ PACKING QUANTITY	KOLİ ADEDİ BOX QUANTITY	ÇUVAL ADEDİ SACK QUANTITY
8721	25 x 20	25	275	325
8731	32 x 20	10	180	200
8732	32 x 25	10	170	200
8741	40 x 20	10	120	140
8742	40 x 25	10	120	140
8743	40 x 32	10	100	110
8752	50 x 25	6	72	90
8753	50 x 32	6	72	84
8754	50 x 40	6	60	66
8763	63 x 32	6	48	54
8764	63 x 40	6	48	54
8765	63 x 50	6	48	42
8775	75 x 50	2	24	28
8776	75 x 63	2	20	26
8786	90 x 63	2	16	20
8787	90 x 75	2	16	18
8797	110 x 75	1	10	12
8798	110 x 90	1	8	10



KABLİN REDÜKSİYON DİRSEK

REDUCING ELBOW

ОТВОД ПЕРЕХОДНОЙ

راوية خرطوم محول

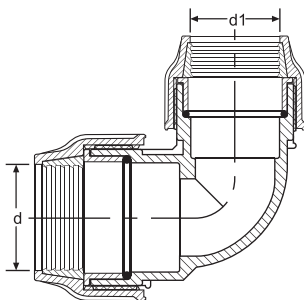

KOD CODE	EBAT / SIZE d x d ₁	AMBALAJ ADEDİ PACKING QUANTITY	KOLİ ADEDİ BOX QUANTITY	ÇUVAL ADEDİ SACK QUANTITY
8921	25 x 20	15	255	285
8932	32 x 25	10	160	180
8943	40 x 32	5	90	100
8954	50 x 40	4	48	60
8965	63 x 50	4	32	40
8976	75 x 63	2	18	24
8987	90 x 75	1	13	16
8998	110 x 90	1	6	9

YEŞİL SERİ / GREEN SERIES COMPRESSION FITTINGS

السلسلة الخضراء / ЗЕЛЕНАЯ СЕРИЯ

KOD CODE	EBAT / SIZE d	AMBALAJ ADEDİ PACKING QUANTITY	KOLİ ADEDİ BOX QUANTITY	ÇUVAL ADEDİ SACK QUANTITY
8811	20	50	750	800
8822	25	25	450	500
8833	32	25	275	300
8844	40	15	150	180
8855	50	12	96	108
8866	63	6	66	72
8877	75	4	36	40
8888	90	4	20	28
8899	110	2	14	16



KABLİN KÖR TAPA

END CAP
ЗАГЛУШКА
راس نهاية خط

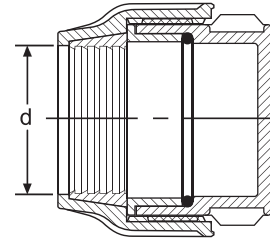

KOD CODE	EBAT SIZE-mm	AMBALAJ ADEDİ PACKING QUANTITY	KOLİ ADEDİ BOX QUANTITY	ÇUVAL ADEDİ SACK QUANTITY
4936	32 - 63	5	150	150
4969	63 - 110	5	45	50



KABLİN ANAHTARI

FITTING SPANNER
соединительный ключ
الوصل مفتاح

YEŞİL SERİ

GREEN SERIES COMPRESSION FITTINGS

ЗЕЛЕНАЯ СЕРИЯ

ةدي دجالء اق رزل ةع وم جم ل

DİKKAT EDİLMESİ GEREKEN HUSUSLAR

- + Poelsan boru bağlantı adaptörleri depolama ve montaj esnasında sert ve keskin cisimlerden uzak tutulmalıdır. Tesisat toprak altına dönecekse, sert ve keskin cisimlerden korumak maksadıyla kum ile kapatılmalıdır. Kesinlikle hasar görmüş adaptörler kullanılmamalıdır.
- + Poelsan boru bağlantı adaptörlerinden maksimum verim alabilmek için, te ve dirsekler 90°, diğer adaptörler 180° açı yapacak şekilde boruya monte edilmelidir. Değişik açılar oluşturan bağlantılar adaptör üzerinde gerilmelere neden olacağından tesisatın ömrü azalacaktır.
- + Dişli bağlantılarda teflon bant kullanılmalıdır. Teflon bant adaptöre su sızıntısını önleyecek kadar ve sıkıca yönünde sarılmalıdır.
- + Montaj esnasında somunun fazla sıkılması adaptör üzerinde ek bir gerilmeye neden olur. Bu şekilde ek bir gerilmeye maruz kalmış olan ürünün garanti verilen basınç değerlerini karşılaması beklenemez. Bu nedenle ürünün plastik olduğu ve sadece sızdırmazlığı sağlayacak kuvvette sıkılması gerektiği unutulmamalıdır.

Tesisatın Son Kontrolü

GÖZLE KONTROL

Tesisatın döşenmesi sırasında hasar görmüş adaptörlerin tespiti için adaptörler mutlaka gözle kontrol edilmelidir.

SIZDIRMAZLIK KONTROLÜ

Tesisatın montajı sonrasında tesisata mutlaka test basıncında su verilmeli ve sızdırmazlık durumu tespit edilmelidir.

SIZINTIYA NEDEN OLABİLECEK UYGULAMALAR

Poelsan boru bağlantı adaptörlerinin dış ölçüleri standartlara uygun olarak üretilmiştir.

- Kullanılan diğer metal ya da plastik malzemenin uygun olmaması,
- Teflon bandın yeterli miktarda kullanılmaması,
- Ürünün aşırı miktarda sıkılması ya da montaj esnasında düzgün monte edilmemesi sonucu ürünün dişlerinin bozulması,
- Montaj esnasında boruya pah açılmaması ve bu nedenle oringin zarar görmesi ya da oringin yerinden çıkması,
- Borulardaki ovaliğin verilen tolerans değerlerinden (± 0.5 mm) daha farklı olması,
- Somunun yanlış monte edilmesi, yeterli miktarda sıkılmaması ya da çok fazla sıkılarak ürünün çatlaması,
- Boru tutucunun oring tutucu ile birleştirilmeden somunun sıkılarak adaptörün montajının yapılması, tesisatınızda sızıntıya neden olabilir.

POINTS TO TAKE INTO CONSIDERATION

- + Poelsan compression fittings should be kept away from hard or sharp objects during storage or installation phases. If the installation will be under the ground, it should be covered with sand in order to keep away from contact with hard and sharp objects. Damaged fittings shouldn't be used strictly.
- + To be able to get the best efficiency from Poelsan compression fittings, tee and elbow pieces should be joined with 90° angle, other fittings should be joined with 180° angle to the system. The installation with different angles will make extra tensile on the fittings and will decrease the lifetime of the system.
- + Teflon band should be used with the threaded pieces. The band should be used enough to prevent water leakage and wrapped on the threaded part in the twisting direction.
- + Over twisting of the nut will cause extra tension on the adaptor. A nut, which is exposed to such an extra tension cannot provide the guaranteed pressure value. Therefore the user should remember that the material is plastic and the nut should be twisted with a force only enough to prevent leakage.

Final Check of the Installation

VISUAL CHECK

During installation, the system should be checked visually in order to determine the damaged adaptors.

LEAKPROOFNESS CHECK

After the installation, the system should be checked with water in testing pressure to determine the water leak.

CONDITIONS THAT MAY CAUSE LEAKAGE

The measurements of the threads of Poelsan compression fittings are produced according to the standards.

- Unfitness of the measurements of the threads of other metal or plastic material,
- Unefficient use of the teflon band,
- Spoiling of the threads because of the improper installation or over twisting of the nut,
- Using unchamfered pipes and causing damage on the o-ring or removing the o-ring,
- The difference of the ovality of pipes from the tolerance values (± 0.5 mm),
- Wrong installation, inefficient twisting or cracking the nut by over twisting,
- Twisting the nut and installing the adaptor without joining the locking ring and the o-ring holder, may cause leakage in the system.

ADAPTÖRLERİN MONTAJ YÖNTEMLERİ

INSTALLATION METHODS

(Ø20, Ø25, Ø32, Ø40, Ø50, mm adaptörler / adaptors)

I MONTAJ YÖNTEMİ / INSTALLATION METHOD

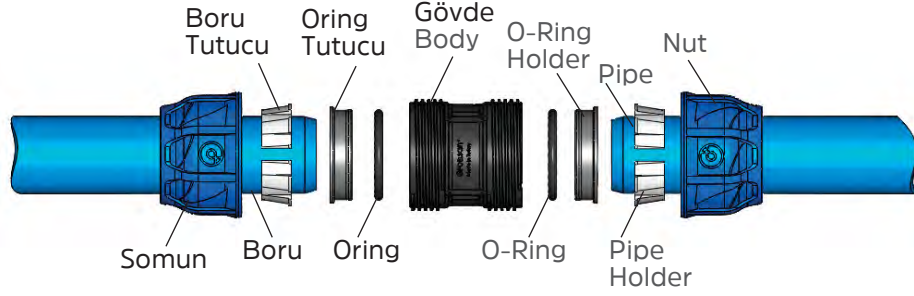

1

Boru uçlarına yaklaşık 15° pah açınız.

Make chamfer on the pipe ends. (Approximately 15°)



2

Boru üzerini, borunun adaptöre geçiş mesafesine göre işaretleyiniz.

Mark the pipe, according to the pipe end point inside the fitting.



3

Adaptörünüzün somununu yaklaşık 3 tam tur döndürüp gevşetiniz.

Untwist 3 full rounds and loosen the nut of the fitting.



4

Boruyu, adaptörünüzün iç kısmındaki * boru dayanma noktasına kadar iyice itiniz.

Push the pipe to * the pipe end point inside the fitting.

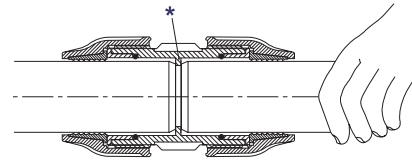

5

Somunu Poelsan Kablo Anahtarı ile sıkınız.

Twist the nut with Poelsan Fitting Spanner.



ADAPTÖRLERİN MONTAJ YÖNTEMLERİ

INSTALLATION METHODS

(Ø63, Ø75, Ø90, Ø110, Ø125 mm adaptörler / adaptors)

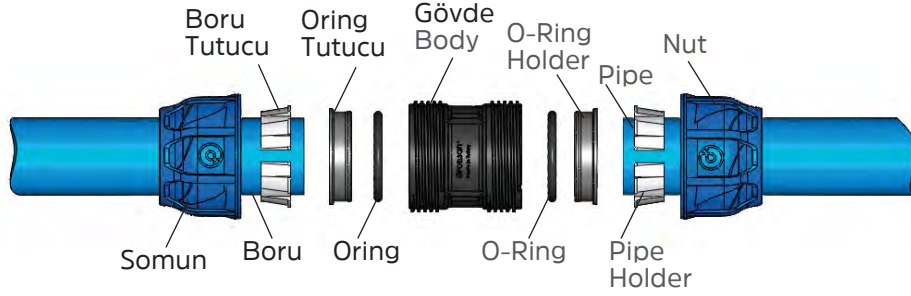

I MONTAJ YÖNTEMİ / INSTALLATION METHOD

1 Pah açmaya gerek yoktur.

There is no need to make chamfer on the pipe end.

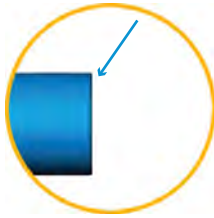

2 Boru üzerini, borunun adaptöre geçiş mesafesine göre işaretleyiniz.

Mark the pipe, according to the pipe end point inside the fitting.



3 Boruya sırasıyla; önce somunu, sonra oring tutucu ve oringi takınız.

Place the nut, o-ring holder and the o-ring on the pipe respectively.



4 Boruyu, adaptörünüzün iç kısmındaki * boru dayanma noktasına kadar iyice itiniz.

Push the pipe to * the pipe end point inside the fitting.

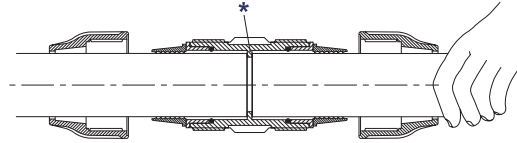

5 Somunu sıkarak adaptörünüzle birleştiriniz. Bu işlem oring ve oring tutucunun kolayca takılmasını sağlayacaktır.

Twist the nut till it is attached to the fitting. This will help the o-ring and the o-ring holder to be placed easily.



6 Somunu gevşeterek açınız.

Untwist and loosen the nut from the fitting.



7 Boru tutucuyu borunun çapı kadar esneterek boruya takınız. Boru üzerinde kaydırarak oring tutucu ile birleştiriniz.

Stretch the locking ring to the diameter of the pipe. Place it on the pipe by sliding it to the o-ring holder.

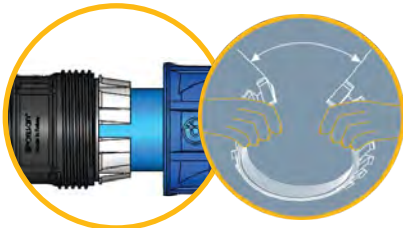

8 Somunu Poelsan Kablo Anahtarı ile sıkınız.

Twist the nut with Poelsan Fitting Spanner.





Koli Kullanılan Ürün Grupları

Product Series in Box

- + Yeni Mavi Seri
- + Mavi Seri
- + Yeşil Seri
- + Priz Kolye Geçmeli
- + Layflat Ek Parçaları & Çıkış Nipelleri
- + Dişli Bağlantı Elemanları
- + Mini Vanalar (DN 8)
- + Mini Vanalar (DN 15)
- + Damla Sulama Kurtağzı Ek Parçaları
- + Yassı Damla Sulama Ek Parçaları
- + Yüzlüklü Yassı Damla Sulama Ek Parçaları
- + Minisprinkler & Mikrofittingler
- + Hat Üstü Damlatıcılar
- + Yeni Priz Kolye
- + Manyetik Lokma Ucu (16080, 16083)
- + Yeşil Seri Küresel Vana
- + Mavi Seri Küresel Vana
- + Boru Delme Aparatı (16096, 16098, 16092, 16094)
- + New Blue Series
- + Blue Series
- + Green Series
- + Clamp Saddles With Slide
- + Layflat Fittings & Offtake Nipples
- + Threaded Fittings
- + Mini Valves (DN 8)
- + Mini Valves (DN 15)
- + Dripline Barbed Fittings
- + Drip Tape Fittings
- + Drip Tape Fittings With Ring
- + Minisprinklers & Microfittings
- + On-Line Drippers
- + New Clamp Saddles
- + Magnetic Socket Wrench (16080, 16083)
- + Green Series Ball Valves
- + Blue Series Ball Valves
- + Driller (16096, 16098, 16092, 16094)

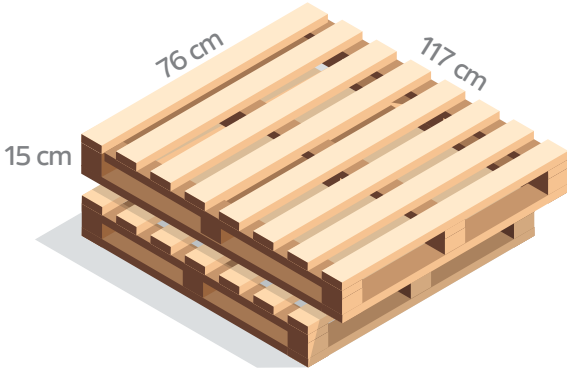

Palet Kullanılan Ürün Grupları

Product Series in The Pallet

- + Vana Kutuları
- + Valve Boxes



Çuval Kullanılan Ürün Grupları

Küresel Vanalar hariç tüm ürünlerimizde çuval kullanılmaktadır.

SERTİFİKALARIMIZ / CERTIFICATES



MARKA TESCİL BELGESİ
BRAND REGISTRATION



KALİTE YÖNETİM BELGESİ
QUALITY MANAGEMENT
SYSTEM CERTIFICATE



ÇEVRE YÖNETİM BELGESİ
ENVIRONMENT MANAGEMENT
SYSTEM CERTIFICATE



İŞ SAĞLIĞI GÜVENLİĞİ
OCCUPATIONAL HEALTH &
SAFETY MANAGEMENT SYSTEM
CERTIFICATE



YENİ MAVİ SERİ
AMERİKA PATENTİ
NEW BLUE SERIES
USA DESIGN PATENT



KIWA BELGESİ
KIWA CERTIFICATE



MAVİ SERİ
TASARIM TESCİL BELGESİ
BLUE SERIES - DESIGN
REGISTRATION CERTIFICATE

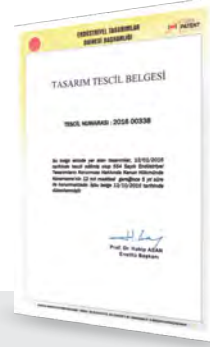

YENİ MAVİ SERİ
TASARIM TESCİL
NEW BLUE SERIES - DESIGN
REGISTRATION CERTIFICATE



YENİ PRİZ KOLYE
TASARIM TESCİL
NEW CLAMP SADDLE
DESIGN REGISTRATION
CERTIFICATE

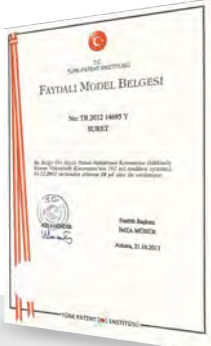

FAYDALI MODEL BELGESİ
UTILITY MODEL CERTIFICATE
FLEXIBLE O-RING HOLDERS



TS ISO 17885 ÇİFT YILDIZ
KRİTERLERİNE UYGUNLUK
TSE ISO 17885 CERTIFICATE of
CONFORMITY to DOUBLE STAR CRITERIA



TS ISO 13460-1 ÇİFT YILDIZ
KRİTERLERİNE UYGUNLUK
TSE ISO 13460-1 CERTIFICATE of
CONFORMITY to DOUBLE STAR CRITERIA



TS ISO 17885 TÜRK
STANDARTLARINA UYGUNLUK
TSE ISO 17885 CERTIFICATE of
CONFORMITY to TSE



TS ISO 13460-1 TÜRK
STANDARTLARINA UYGUNLUK
TSE ISO 13460-1 CERTIFICATE of
CONFORMITY to TSE



TS 13716 VANA KUTULARI
TÜRK STANDARTLARINA UYGUNLUK
TS 13716 VALVE BOXES CERTIFICATE of
CONFORMITY to TSE



TS ISO 9911 VANALAR TSE
KRİTERLERİNE UYGUNLUK
TS ISO 9911 VALVES CERTIFICATE of
CONFORMITY to TSE



TS ISO 9261 TÜRK
STANDARTLARINA UYGUNLUK
TS ISO 9261 CERTIFICATE of
CONFORMITY to TSE





07/2019

Şabanoğlu OSB Mahallesi Ulubatlı Caddesi No: 6 Tekkeköy SAMSUN TÜRKİYE
Tel: +90 362 266 75 24 Faks: +90 362 266 77 51 GSM: +90 544 366 69 64

www.poelsan.com |    poelsan |   poelsanplastik | poelsan@poelsan.com